

SAFETY

Use the proper fuse
To avoid the hazard, use a fuse of the correct type
Do not operate the oscilloscope with the cover removed
To avoid explosion, do not operate the oscilloscope with a damaged atmosphere

Symbol in This Manual
This symbol indicates where applicable necessary or
caution is to be taken

Power Source
This instrument operates from a power source that does
not have more than 250 V rms between the main and
ground or between other supply conductors

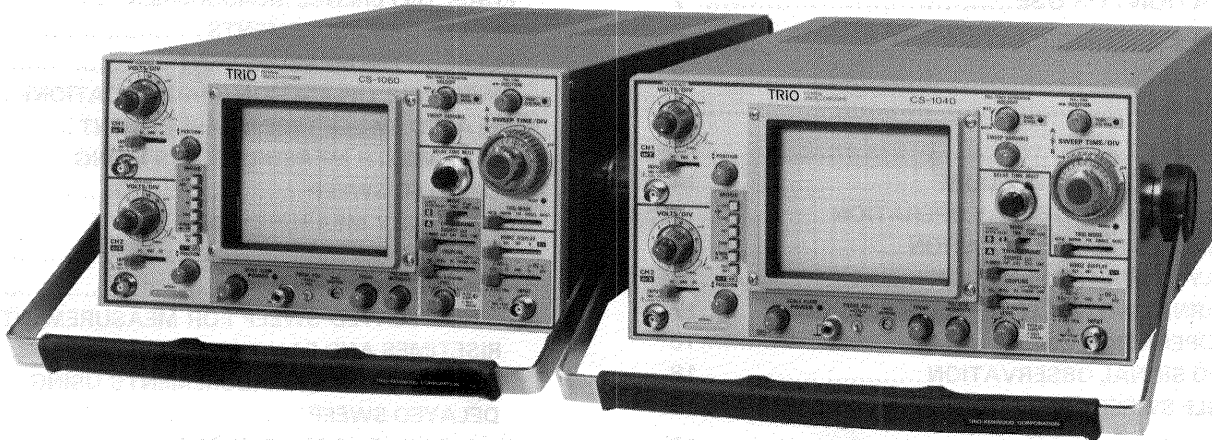
Remove the Cover or Panel
To avoid electrical shock, do not remove the cover or panel
unless the power cord is disconnected from the rear panel

Grounding the Product
This instrument is grounded through the power cord. To avoid
electrical shock, do not touch the metal chassis or other
conductive parts of the instrument while the power cord is
connected to a power source

CS-1060 CS-1040 (TRIPLE TRACE OSCILLOSCOPE)

INSTRUCTION MANUAL


CONTENTS



TRIO

SAFETY

Symbol in This Manual

 This symbol indicates where applicable cautionary or other information is to be found.

Power Source

This equipment operates from a power source that does not apply more than 250 V rms between the supply conductors or between either supply conductor and ground. A protective ground connection by way of the grounding conductor in the power cord is essential for safe operation.

Grounding the Product

This equipment is grounded through the grounding conductor of the power cord. To avoid electrical shock, plug the power cord into a properly wired receptacle before connecting to the equipment input or output terminals.

Use the Proper Power Cord

Use only the power cord and connector specified for your product.

Use the Proper Fuse

To avoid fire hazard, use a fuse of the correct type.

Do not Operate in Explosive Atmospheres

To avoid explosion, do not operate this product in an explosive atmosphere.

Do not Remove Cover or Panel

To avoid personal injury, do not remove the cover or panel. Refer servicing to qualified personnel.

Voltage Conversion

If the power source is not applied to your product, contact your dealer. To avoid electrical shock, do not perform the voltage conversion.

CONTENTS

SAFETY	2	PULSE WIDTH MEASUREMENTS	22
FEATURES	3	PULSE RISE TIME AND FALLTIME MEASUREMENTS	22
SPECIFICATIONS	4	TIME DIFFERENCE MEASUREMENTS	23
PREPARATION FOR USE	7	PHASE DIFFERENCE MEASUREMENTS	24
CONTROLS AND INDICATORS	9	RELATIVE MEASUREMENTS	24
FRONT PANEL	9	PULSE JITTER MEASUREMENT	26
REAR PANEL	13	SWEEP MULTIPLICATION (MAGNIFICATION)	26
OPERATION	14	DELAYED SWEEP TIME MEASUREMENT	27
INITIAL STARTING PROCEDURE	14	PULSE WIDTH MEASUREMENTS USING DELAYED SWEEP	27
(1) NORMAL SWEEP DISPLAY OPERATION	14	FREQUENCY MEASUREMENTS USING DELAYED SWEEP	28
(2) MAGNIFIED SWEEP OPERATION	17	PULSE REPETITION TIME	29
(3) DELAYED SWEEP OPERATION	17	USING DELAYED SWEEP FOR MEASUREMENTS OF RISETIMES AND FALLTIMES	29
(4) ALTERNATING SWEEP OPERATION	17	TIME DIFFERENCE MEASUREMENTS USING DELAYED SWEEP	29
(5) X-Y OPERATION	18	TRIPLE-TRACE APPLICATIONS	30
(6) VIDEO SIGNAL OBSERVATION	18	OBSERVATION OF THE START PORTION OF THE IRREGULAR WAVEFORM	30
(7) SINGLE SWEEP OPERATION	18	X-Y APPLICATION	31
APPLICATION	19	ACCESSORIES	32
PROBE COMPENSATION	19		
TRACE ROTATION COMPENSATION	19		
DC VOLTAGE MEASUREMENTS	19		
MEASUREMENTS OF THE VOLTAGE BETWEEN TWO POINTS ON A WAVEFORM	20		
ELIMINATION OF UNDESIRE SIGNAL COMPONENTS	20		
TIME MEASUREMENTS	21		
FREQUENCY MEASUREMENTS	21		

Note: This instruction manual is described for two models. Refer to item applied to your product.

FEATURES

1. Vertical axis has high sensitivity and wide bandwidth and especially covers fully specified frequency response at 5mV/div for all models.
 - CS-1060 ;
 - 1mV/div, 2mV/div : DC to 20 MHz, -3 dB
 - 5mV/div : DC to 60 MHz, -3 dB
 - CS-1040 ;
 - 1mV, 2mV/div : DC to 15 MHz, -3 dB
 - 5mV/div : DC to 40 MHz, -3 dB
2. Vertical sensitivity range is selectable from 1mV/div to 5V/div with rotary switch continuously.
3. Time base permits the high sweep speed.
 - CS-1060; 5nsec/div ($\times 10$ MAG)
 - CS-1040; 10nsec/div ($\times 10$ MAG)
4. Vertical sensitivity error and sweep rate error are $\pm 3\%$ and accurate measurements are provided.
5. The 150 mm rectangular, domed mesh type CRT with internal graticule provides high brightness and accurate measurements, free of parallax error.
 - CS-1060; acceleration voltage; 16 kV.
 - CS-1040; acceleration voltage; 12 kV.
6. For convenience in making rise time measurements, the 0%, 10%, 90% and 100% levels are marked on the graticule scale of the CRT.
7. The built-in Auto-focus circuit keeps the waveforms in clear focus automatically regardless of the INTENSITY control setting.
8. Trace rotation is electrically adjustable from the front panel.
9. By SCALE ILLUM control, the waveform is easy observed in darkened area and the photograph of the waveform is easy provided a single photograph of the waveform superimposed on the graticule scale.
10. Delay sweep modes are available in not only Continuous Delay (STARTS AFTER DELAY) and trigger Delay (TRIG) but also both A and B zero Delay (DELAY TIME ZERO) allowing to observe the whole extent of any complicated pulse train with magnification as necessary.
11. Single sweep permits viewing and photographing one-time events.
12. TRIPLE mode presents a triple-trace oscilloscope; even six traces of waveforms may be observed simultaneously with HORIZ DISPLAY set at ALT.
13. The delay line permits viewing of leading edge of high-frequency, fast risetime pulses.
14. Selectable AUTO FREE RUN function provides sweep without trigger input signal.
15. The FRAME-LINE switch provides selection of sync pulse for sweep triggering from small amplitude to large amplitude without adjusting when viewing composite video waveforms.
16. Vertical mode automatically provides the trigger signal with TRIG SOURCE and V. MODE switches.
17. X-Y operation is easy provided by one-touche.
18. Provides with CH1 OUTPUT terminal to monitor input signal of CH1.
19. SWEEP GATE and SWEEP OUTPUT terminals are provides.
20. DELAY TIME MULT permits the accurate time measurements with the dial scale.

SPECIFICATIONS

	CS-1060	CS-1040
CRT	150HTM31 Rectangular, with internal graticule	150JTM31 Rectangular, with internal graticule
Acceleration Voltage	16 kV	12 kV
Display Area	8 × 10 div (1 div = 10 mm)	
VERTICAL AXIS	CH1 and CH2	
Sensitivity	1 mV/div to 5 V/div, ±3%	
Attenuator	12 steps, 1 mV/div to 5 V/div in 1-2-5 sequence. Vernier control for fully adjustable sensitivity between steps.	
Input Impedance	1 MΩ ± 2%, approx 20 pF	
Frequency Response		
5mV/div to 5V/div	DC; DC to 60 MHz, -3 dB AC; 5 Hz to 60 MHz, -3 dB	DC; DC to 40 MHz, -3 dB AC; 5 Hz, to 40 MHz, -3 dB
1 mV/div, 2 mV/div	DC; DC to 20 MHz, -3 dB AC; 5 Hz to 20 MHz, -3 dB	DC; DC to 15 MHz, -3 dB AC; 5 Hz to 15 MHz, -3 dB
Rise Time	5.8 nsec or less (60 MHz) 17.5 nsec or less (20 MHz)	8.8 nsec or less (40 MHz) 23.4 nsec or less (15 MHz)
Signal Delay Time	Approx. 20 nsec on the CRT screen	
Crosstalk	-40 dB minimum	
Operating Modes	CH1; single trace CH2; single trace ADD; CH1 + CH2 added as a single trace DUAL; CH1 and CH2, dual trace TRIPLE; CH1, CH2 and CH3 triple trace ALT; dual trace or triple trace, alternating CHOP; dual or triple trace, chopped	
Chop Frequency	Approx. 250 kHz	
Channel Polarity	Normal or inverted, channel 2 only inverted	
⚠ Maximum Input voltage	500 Vp-p or 250 V (DC + AC peak)	
Non-Distorted Maximum Amplitude	More than 8 div (DC to 60 MHz)	More than 8 div (DC to 40 MHz)
VERTICAL AXIS	CH3	
Sensitivity	0.1 V/div and 1 V/div ±3%	
Input Resistance	1 MΩ ± 2%	
Input Capacitance	Approx 27pF	
Frequency Response	DC: DC to 60 MHz, -3 dB AC: 5 Hz to 60 MHz, -3 dB	DC: DC to 40 MHz, -3 dB AC: 5 Hz to 40 MHz, -3 dB
Rise Time	5.8 nsec or less	8.8 nsec or less
Signal Delay Time	Same as CH1 and CH2	
⚠ Maximum Input Voltage	50 V (DC + AC peak)	
HORIZONTAL AXIS	Input thru CH2, × 10 MAG not included	
Operating Modes	With HORIZ DISPLAY switch, X-Y operation is selectable CH1; Y axis CH2; X axis	
Sensitivity	Same as vertical axis (CH2)	

		CS-1060			CS-1040		
Input Impedance		Same as vertical axis (CH2)					
Frequency Response		DC; DC to 1 MHz, -3 dB AC; 5 Hz to 1 MHz, -3 dB					
X-Y Phase Difference		3° or less at 100 kHz					
△ Maximum Input Voltage		Same as vertical axis (CH2)					
SWEEP							
Type		A; A sweep ALT; A sweep (intensified for duration of B sweep) and B sweep (delayed sweep) alternating INT; Duration of B sweep is displayed as an intensified portion of A sweep. B; Delayed sweep X-Y; X-Y oscilloscope					
Sweep Time	A	0.05 μ s/div to 0.5 s/div, \pm 3% in 22 ranges, in 1-2-5 sequence. Vernier control provides fully adjustable sweep time between steps.			0.1 μ s/div to 0.5 s/div, \pm 3% in 21 ranges, in 1-2-5 sequence. Vernier control provides fully adjustable sweep time between steps.		
	B	0.05 μ s/div to 50 ms/div, \pm 3% in 19 ranges, in 1-2-5 sequence.			0.1 μ s/div to 50 ms/div, \pm 3% in 18 ranges, in 1-2-5 sequence.		
Sweep Magnification		\times 10 (ten times) \pm 5%					
Linearity		\pm 3% all ranges, \pm 5% on 0.05 μ s/div to 0.1 μ s/div range at \times 10 MAG.					
Holdoff		Continuously variable from NORM to more than ten times (MAX)					
Trace Separation		B sweep can be separated from A sweep up to 4 divisions, continuously adjustable.					
Delay Method		Continuous delay (STARTS AFTER DELAY), Trigger delay (TRIG), Zero delay (DELAY TIME ZERO)					
Delay Time		From 100 nsec to 0.5sec. Available delay time is 0.2 to 10 times the A sweep time setting, continuously adjustable.					
Time difference measurement accuracy		\pm 2%					
Delay Jitter		1/20000 of ten times of A sweep time setting					
TRIGGERING							
Trigger mode		AUTO, NORM, FIX, SINGLE					
Trigger source		V.MODE; Trigger selected by vertical MODE switch. CH1; Triggered by CH1 signal CH2; Triggered by CH2 signal CH3/EXT; Triggered by CH3 signal LINE; Triggered by line voltage					
Coupling		AC, HFrej, DC, VIDEO FRAME, VIDEO LINE					
Trigger sensitivity		FREQ.RANGE	INT	EXT	FREQ.RANGE	INT	EXT
	DC	DC -60 MHz	1 div	0.1 Vp-p	DC -40 MHz	1 div	0.1VP-P
	AC	Same as for DC but increased minimum level below 10 Hz					
	AC, HF rej	Increased minimum level below 10 Hz and above 20 kHz					
	VIDEO	FRAME, LINE	1 div	0.1 Vp-p	FRAME, LINE	1 div	0.1 Vp-p
		AUTO: Same as above specifications for above 50 Hz. FIX: Same as above specifications for above 50 Hz.					

	CS-1060	CS-1040
PROBE ADJ. VOLTAGE	0.5 V, ±6%, square wave, positive polarity, approx 1 kHz	
INTENSITY MODULATION		
Sensitivity	TTL compatible positive voltage increases brightness, negative voltage decreases brightness.	
Input Impedance	Approx. 10 kΩ	
Usable Frequency Range	DC to 5 MHz	DC to 3.5 MHz
⚠ Maximum Input Voltage	50 V (DC + AC peak)	
VERTICAL AXIS SIGNAL OUTPUT	CH1 OUTPUT	
Output Voltage	Approx. 50 mV/div into 50 Ω	
Output Impedance	Approx. 50 Ω	
Frequency Response		
5 mV/div to 5 V/div	100 Hz to 60 MHz, -3 dB into 50 Ω	100 Hz to 40 MHz, -3 dB into 50 Ω
1 mV/div, 2 mV/div	100 Hz to 20 MHz, -3 dB into 50 Ω	100 Hz to 15 MHz, -3 dB into 50 Ω
GATE OUTPUT		
Output Voltage	TTL compatible	
Output Impedance	Approx. 220 Ω	
SWEEP OUTPUT		
Output Voltage	1 Vp-p	
Output Impedance	Approx. 1 kΩ	
POWER REQUIREMENT		
Power Supply	100 V/120 V/220 V/240 V ±10%	
Line Frequency	50/60 Hz	
Power Consumption	Approx. 65 W	
DIMENSIONS (W × H × D)	304(346) × 160(173) × 401(461) mm () dimensions include protrusion from basic outline dimensions	
WEIGHT	Approx. 11 kg	
ENVIRONMENTAL		
Within Specifications	10°C to 35°C, 85% max. relative humidity	
Full Operation	0°C to 50°C, 90% max. relative humidity	
ACCESSORIES SUPPLIED		
Probe	PC-29.....2	PC-20.....2
Spare Fuse	2 A.....2 1 A.....2	
Instruction Manual	1	

* Circuit and rating are subject to change without notice due to developments in technology.

PREPARATION FOR USE

SAFETY

Before connecting the instrument to a power source, carefully read the following information, then verify that the proper power cord is used and the proper line fuse is installed for power source. The specified voltage is shown at the left side of the power cord on the rear panel. If the power cord is not applied for specified voltage, there is always a certain amount of danger from electric shock.

Line voltage

This instrument operates using ac-power input voltages that 100/120/220/240 V at frequencies from 50 Hz to 60 Hz.

Power cord

The ground wire of the 3-wire ac power plug places the chassis and housing of the oscilloscope at earth ground. Do not attempt to defeat the ground wire connection or float the oscilloscope; to do so may pose a great safety hazard. The appropriate power cord is supplied by an option that is specified when the instrument is ordered.

The optional power cords are shown as follows in Fig. 1.

Line fuse

The fuse holder is located on the rear panel and contains the line fuse. Verify that the proper fuse is installed by replacing the line fuse.

EQUIPMENT PROTECTION

1. Never allow a small spot of high brilliance to remain stationary on the screen for more than a few seconds. The screen may become permanently burned. A spot will occur only when the scope is set up for X-Y operation and no signal is applied. Either reduce the intensity so the spot is barely visible, switch back to normal sweep operation when no signal is applied, or set up the scope for spot blanking.
2. Never cover the ventilating holes on the top of the oscilloscope, as this will increase the operating temperature inside the case.
3. Never apply more than the maximum rating to the oscilloscope inputs.
CH1, CH2 INPUT jacks: 500 Vp-p or 250 V (dc+ac peak)
CH3 INPUT jack: 50 V (dc+ac peak)
Z axis INPUT jack: 50 V (dc+ac peak)
Never apply external voltage to the oscilloscope output terminals.
4. Always connect a cable from the earth ground (GND) jack of the oscilloscope to the chassis of the equipment under test. Without this caution, the entire current for the equipment under test may be drawn through the probe clip leads under certain circumstances. Such conditions could also pose a safety hazard, which the ground cable will prevent.

5. Always use the probe ground clips for best results. Do not use an external ground wire in lieu of the probe ground clips, as undesired signals may be introduced.
6. Operation adjacent to equipment which produces strong ac magnetic fields should be avoided where possible. This includes such devices as large power supplies, transformers, electric motors, etc., that are often found in an industrial environment. Strong magnetic shields can exceed the practical CRT magnetic shielding limits and result interference and distortion.
7. Probe compensation adjustment matches the probe to the input of the scope. For best results, compensation of probe should be adjusted initially, then the same probe always used with the input of scope. Probe compensation should be readjusted whenever a probe from a different scope is used. (See page 19)
8. Push-push switches are used for $\times 10$ MAG and SLOPE ("+" and "-"); every push of the switch alternates the mode to the other one assigned to the same switch. Look at the LED indicators for which modes are working.
9. In X-Y operation, do not pull out the PULL $\times 10$ MAG switch. If pulled out it, noise may appear on the waveform.


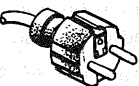
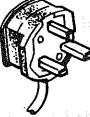

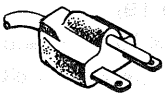

Plug configuration	Power cord and plug type	Factory installed instrument fuse	Line cord plug fuse
	North American 120 volt/60 Hz Rated 15 amp (12 amp max; NEC)	2 A, 250 V Fast blow AGC/3AG	None
	Universal Europe 220 volt/50 Hz Rated 16 amp	1 A, 250 V Fast blow 5 × 20 mm	None
	U.K. 240 volt/50 Hz Rated 13 amp	1 A, 250 V Fast blow 5 × 20 mm	1 A Type C
	Australian 240 volt/50 Hz Rated 10 amp	1 A, 250 V Fast blow 5 × 20 mm	None
	North American 240 volt/60 Hz Rated 15 amp (12 amp max; NEC)	1 A, 250 V Fast blow AGC/3AG	None
	Switzerland 240 volt/50 Hz Rated 10 amp	1 A, 250 V Fast blow AGC/3AG 5 × 20 mm	None

Fig. 1 Power Input Voltage Configuration

CONTROLS AND INDICATORS

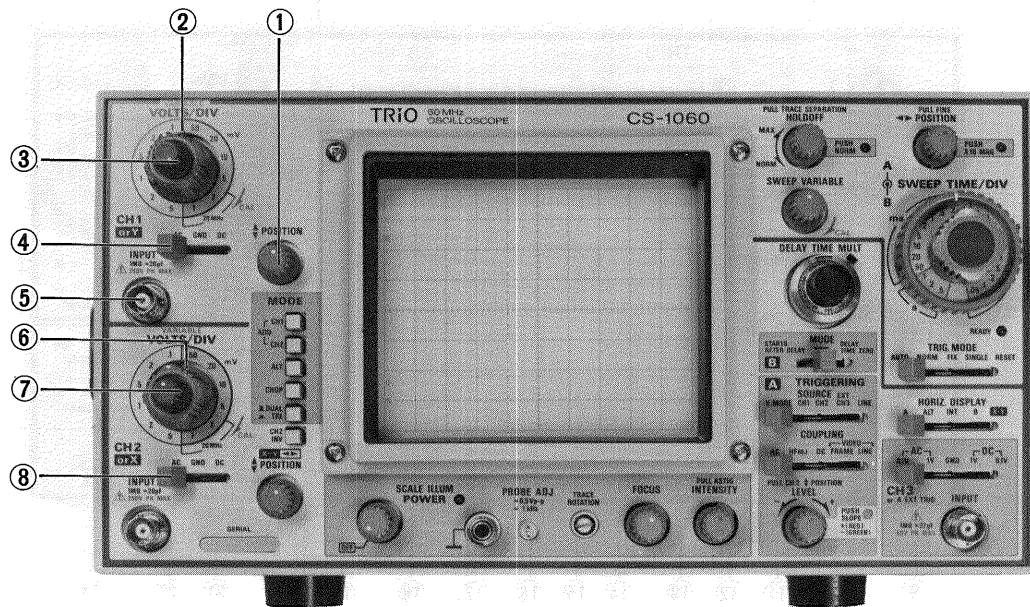


Fig. 2

FRONT PANEL

① POSITION

Rotation adjusts vertical position of channel 1 trace. In X-Y operation, rotation adjusts vertical position of display.

② VOLTS/DIV

Vertical attenuator for channel 1; provides step adjustment of vertical sensitivity. When VARIABLE control ③ is set to CAL, vertical sensitivity is calibrated in 12 steps from 5 V/div to 1 mV/div.

For X-Y operation, this control provides step adjustment of vertical sensitivity.

③ VARIABLE Control

Rotation provides fine control of channel 1 vertical sensitivity. In the fully clockwise (CAL) position, the vertical attenuator is calibrated. For X-Y operation, this control serves as the Y axis attenuation fine adjustment.

④ AC-GND-DC

Three-position lever switch which operates as follows:

- AC: Blocks dc component of channel 1 input signal.
- GND: Opens signal path and grounds input to vertical amplifier. This provides a zero-signal base line, the position of which can be used as a reference when performing dc measurements.
- DC: Direct input of ac and dc component of channel 1 input signal.

⑤ INPUT Jack

Vertical input for channel 1 trace. Vertical input for X-Y operation.

⑥ VOLTS/DIV

Vertical attenuator for channel 2; provides step adjustment of vertical sensitivity. When VARIABLE control ⑦ is set to CAL, vertical sensitivity is calibrated in 12 steps from 5 V/div to 1 mV/div.

In X-Y operation, this control provides step adjustment of horizontal sensitivity.

⑦ VARIABLE Control

Rotation provides fine control of channel 2 vertical sensitivity. In the fully clockwise (CAL) position, the vertical attenuator is calibrated. In X-Y operation, this control becomes the fine horizontal gain control.

⑧ AC-GND-DC

Three-position lever switch which operates as follows:

- AC: Blocks dc component of channel 2 input signal.
- GND: Opens signal path and grounds input to vertical amplifier. This provides a zero-signal base line, the position of which can be used as a reference when performing dc measurements.
- DC: Direct input of ac and dc component of channel 2 input signal.

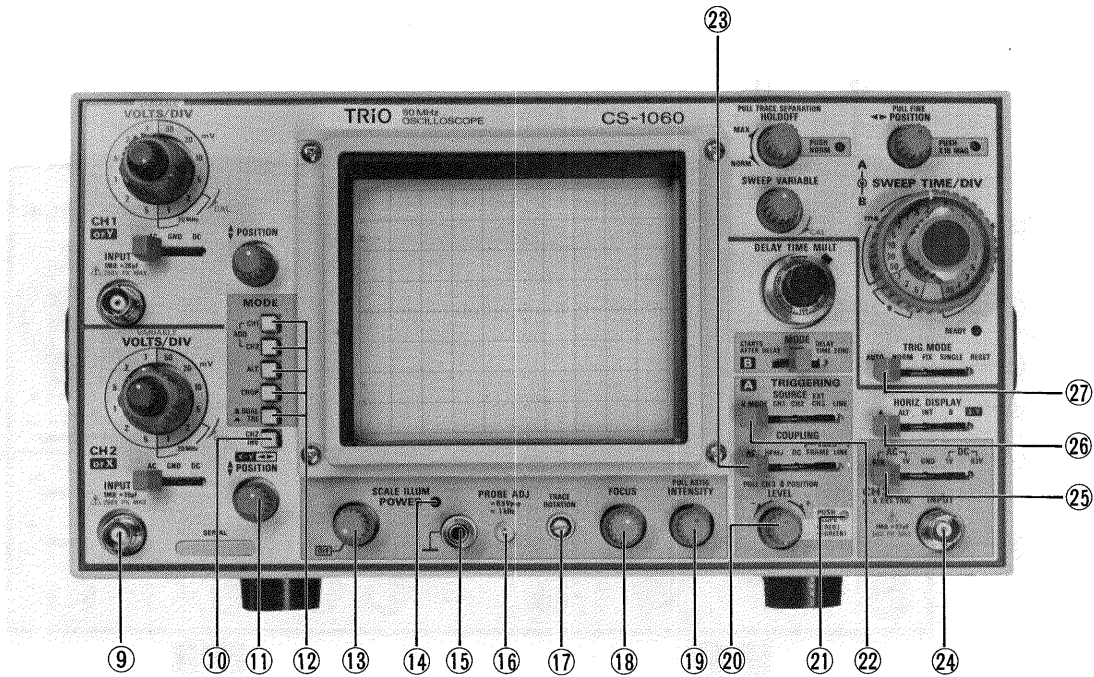


Fig. 3

9 INPUT Jack

Vertical input for channel 2 trace in normal sweep operation. External horizontal input in X-Y operation.

10 CH2 INV

In the NORM position (button released), the channel 2 signal is non-inverted. In the INV position (button engaged), the channel 2 signal is inverted.

11 POSITION, X-Y

Rotation adjusts vertical position of channel 2 trace. In X-Y operation adjusts horizontal position of display.

12 MODE

Push button switch assembly; selects the basic operating modes of the oscilloscope.

CH1: Only the input signal to channel 1 is displayed as a single trace.

CH2: Only the input signal to channel 2 is displayed as a single trace.

ADD: When both CH1 and CH2 buttons are engaged, (CH1+CH2) the waveforms from channel 1 and channel 2 inputs are added and the sum is displayed as a single trace. When the CH2 INV (10) button is engaged, the waveform from channel 2 is subtracted from the channel 1 waveform and the difference is displayed as a single trace.

ALT: Alternate sweep is selected regardless of sweep time as dual trace (CH1 and CH2) or triple trace (CH1, CH2 and CH3)

CHOP:

Chop sweep is selected regardless of sweep time at approximately 250 kHz as dual trace (CH1 and CH2) or triple trace (CH1, CH2 and CH3).

DUAL/

TRIPLE: When this button released, dual trace mode allows to observe waveforms of channel 1 and channel 2 input signals.

When engaged this button, if either ALT or CHOP switch is pushed in, triple trace mode presents traces of channel 1, channel 2 and channel 3 input waveforms.

13 POWER, SCALE ILLUM

Fully counterclockwise rotation of this control (OFF position) turns off oscilloscope. Clockwise rotation turns on oscilloscope. Further clockwise rotation of the control increases the illumination level of scale.

14 PILOT Lamp

Lights when oscilloscope is turned on.

15 GND terminal/binding post.

Earth and chassis ground.

16 PROBE ADJ.

Provides approximately 1 kHz, 0.5 Volt peak-to-peak square wave signal. This is useful for probe compensation adjustment.

⑰ TRACE ROTATION

Electrically rotates trace to horizontal position. Strong magnetic fields may cause the trace to be tilted. The degree of tilt may vary as the scope is moved from one location to another. In these cases, adjust this control.

⑱ FOCUS

Adjusts the trace for optimum focus.

⑲ INTENSITY/PULL ASTIG

INTENSITY: Clockwise rotation of this control increases the brightness of the trace.

ASTIG: Pull out and rotate this knob. Astigmatism adjustment provides optimum spot roundness when used in conjunction with FOCUS control regardless intensity control.

⑳ LEVEL/PUSH SLOPE/PULL CH3 \blacktriangle POSITION

LEVEL: Trigger level adjustment determines point on waveform where sweep starts.

When COUPLING switch is selected in VIDEO-FRAME or LINE, the trigger level adjustment has no effect.

SLOPE: + equals most positive point of triggering and - equals most negative point of triggering. Push-push switch selects positive or negative slope.

CH3 \blacktriangle POSITION:

When pulled out, rotation adjusts vertical position of channel 3 trace. This control is used when the vertical MODE is selected to TRIPLE, regardless of LEVEL setting and SLOPE controls.

㉑ SLOPE indicator

Red LED lights when the sweep is triggered on the positive-going slope of input signal and green LED lights when the sweep is triggered negative-going slope of input signal.

㉒ SOURCE

Five-position lever switch; selects triggering source for the sweep, with following positions;

V. MODE: The trigger source is determined by vertical MODE selection.

CH1: Channel 1 signal is used as a trigger source.

CH2: Channel 2 signal is used as a trigger source.

ADD: The algebraic sum of channel 1 and channel 2 signal is the trigger source. (If CH2 INV engaged, the difference becomes the trigger source.)

ALT: Display is alternately triggered by CH1 and CH2 (dual-trace operation) or CH1, CH2 and CH3 (triple-trace operation).

CHOP: The display cannot be synchronized with the input signal since the chopping signal becomes the trigger source.

CH1: Sweep is triggered by channel 1 signal regardless of vertical MODE selection.

CH2: Sweep is triggered by channel 2 signal regardless of vertical MODE selection.

EXT/

CH3: Sweep is triggered by signal applied to EXT TRIG INPUT jack ㉔.

LINE: Sweep is triggered by line voltage (50/60 Hz).

㉓ COUPLING

Five-position lever switch; selects coupling for sync trigger signal.

AC: Trigger is ac coupled. Blocks dc component of input signal; most commonly used position.

HFrej: Sync signal is coupled through a low-pass filter to eliminate high frequency components for stable triggering of low frequency signals.

DC: The sync signal is dc coupled for sync which includes the effects of dc components.

VIDEO

FRAME: Vertical sync pulses of a composite video signal are selected for triggering.

VIDEO

LINE: Horizontal sync pulses of a composite video signal are selected for triggering.

㉔ CH3 or A EXT TRIG

Input terminal of channel 3 signal or external trigger signal of A TRIG. When vertical MODE is set at TRI, not only channel 1 and channel 2 input signals but channel 3 signal is observable simultaneously.

㉕ AC (0.1 V, 1 V)-GND-DC(1 V, 0.1 V)

Five position lever switch selects channel 3 input coupling and channel 3 vertical attenuator (0.1V/div, 1 V/div).

㉖ HORIZ. DISPLAY

Used to select the horizontal display mode.

A: Only A sweep is operative with the B sweep dormant.

ALT: A sweep alternates with the B sweep. For this mode of operation, the B sweep appears as an intensified section on the A sweep.

INT: Duration of the B sweep appears as an intensified section on the A sweep.

B: Only delayed B sweep is operative.

X-Y: Channel 1 becomes the Y axis and channel 2 becomes the X axis for X-Y operation. The setting of the vertical MODE and TRIG MODE switches have no effect.

㉗ TRIG MODE

Five-position lever switch; selects triggering mode.

AUTO: Triggered sweep operation. When trigger signal is present, automatically generates sweep (free runs in absence of trigger signal.)

NORM: Normal triggered sweep operation. No trace is presented when a proper trigger signal is not applied.

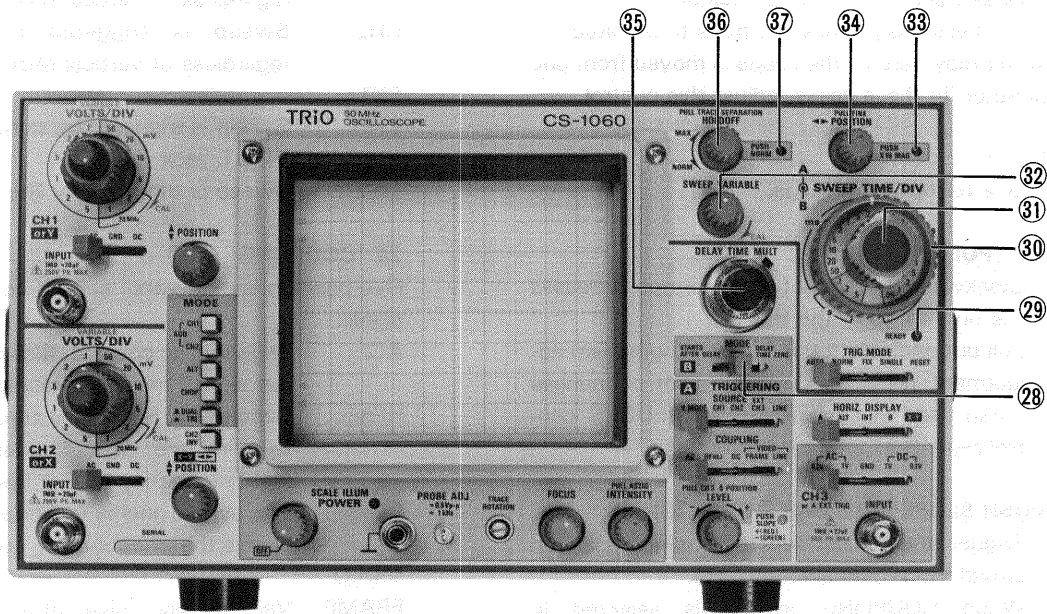


Fig. 4

FIX: Same as automatic mode, automatically generates sweep (free runs) in absence of trigger signal except trigger threshold is automatically fixed at center of input signal regardless of setting of LEVEL control.

SINGLE: Single sweep operation. Note that in this mode, simultaneous observation of both the A and B sweeps is not possible.

Note;

For dual or triple trace, single sweep operation, vertical MODE must not be set to ALT. Use the CHOP mode instead.

RESET: This is the reset switch for single sweep operation. Switching the RESET side initiates a single sweep which will begin when the next sync trigger occurs.

28 B MODE

Used to select delay sweep mode.

STARTS AFTER DELAY:

B sweep is triggered immediately after the delay set by A SWEEP TIME/DIV and DELAY TIME MULT controls.

TRIG: "Triggerable After Delay" operation B Sweep triggering is inhibited during delay period set by A SWEEP TIME/DIV and DELAY TIME MULT controls. B Sweep is triggered by first occurrence of proper trigger signal after the delay. In this

case the source of the B trigger is the same as the source of the A trigger. Both A and B trigger levels are adjusted by TRIG LEVEL control.

DELAY TIME ZERO:

A and B sweeps are triggered simultaneously, regardless of DELAY TIME MULT setting. This mode is used to observe the first portion of complicated period of pulse trains with magnification.

29 Ready Indicator

In SINGLE triggering mode, lights when TRIG MODE switch is set to RESET and goes off when sweep is completed.

30 A SWEEP TIME/DIV

Horizontal coarse A sweep time selector.

Selects calibrated sweep times of 0.05 μ s/div to 0.5 s/div in 22 steps (CS-1040... 0.1 μ s/div to 0.5 s/div in 21 steps) when SWEEP VARIABLE control 32 is set to CAL position (fully clockwise).

31 B SWEEP TIME/DIV

Coarse horizontal B sweep time selector.

Selects sweep times of 0.05 μ s/div to 50 ms/div in 19 steps (CS-1040...0.1 μ s/div to 50 ms/div in 18 steps). B sweep time selector should be set faster than A sweep time.

32 SWEEP VARIABLE Control

Fine A sweep time adjustment. In the fully clockwise (CAL) position, the sweep time is calibrated.

No fine adjustment is available for the B sweep time.

33 × 10 MAG Indicator

Lights when × 10 Sweep magnification is selected.

34 POSITION/PUSH × 10 MAG/PULL FINE

Rotation adjusts horizontal position of trace.

Rotation becomes fine adjustment of horizontal position of trace when pulled out. Ten times sweep expands when pushed in.

Push-push switch alternately turns ×10 MAG on and off (ten times sweep expansion).

35 DELAY TIME MULT

Adjusts the start time of the B sweep to some delay time after the start of A sweep. The delay time may be set to values between 0.2 and 10 times the setting of the A SWEEP TIME/DIV control.

36 HOLDOFF/PUSH NOR/PULL TRACE SEPARATION

HOLDOFF: Rotation adjusts holdoff (trigger inhibit period beyond sweep duration) when extinguished the PUSH NOR indicator **37**.

Counterclockwise rotation increases holdoff period from NORM to max more than ten times.

TRACE SEPARATION:

Adjusts vertical separation between A sweep and B sweep (control has effect only in the ALT of HORIZ. DISPLAY).

Clockwise rotation increases separation; B sweep moves down with respect to A sweep up to 4 divisions.

In this case, HOLDOFF control has no effect.

PUSH NOR:

Push-push switch; holdoff selector switch; once pushed in, PUSH NOR indicator lights up.

Pushed in again, PUSH NOR indicator extinguishes, and is holdoff adjustment is available.

37 PUSH NOR Indicator

NOR lamp indicates that holdoff can not be adjusted.

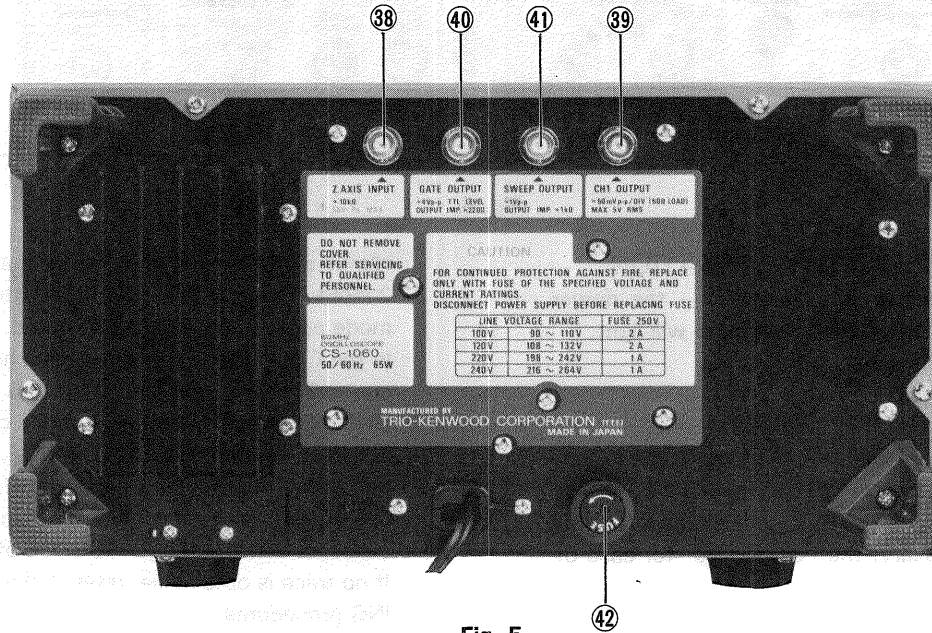


Fig. 5

38 Z AXIS INPUT Jack

External intensity modulation input; TTL compatible. Positive voltage increases brightness, negative voltage decreases brightness.

39 CH1 OUTPUT Jack

CH1 vertical output signal connector.

AC coupled output connector.

This connector is used to measure the frequency by connecting the frequency counter. When the frequency counter measures frequency at 1 mV/div, the equipment may not indicate the correct indication of the frequency due to the noise effect. Then set the VOLTS/DIV to other range or rotate the VARIABLE control **3** to except CAL position For stable operation, do not connect CH1 OUTPUT to channel 2 input as cascaded operation.

40 GATE OUTPUT Jack

Output connector of square wave triggered with A sweep.

41 SWEEP OUTPUT Jack

Output connector of saw-tooth wave triggered with A sweep.

42 Fuse Holder

Contains the line fuse. Verify that the proper fuse is installed when replacing the line fuse.

100 V, 120 V 2 A

220 V, 240 V 1 A

OPERATION

INITIAL STARTING PROCEDURE

Until you familiarize yourself with the use of all controls, the following procedure may be used to standardize the initial setting of controls as a reference point and to obtain

trace on the CRT in preparation for waveform observation. When using the probe(s), refer to probe's instructions and "PROBE COMPENSATION" listed in APPLICATION of this manual.

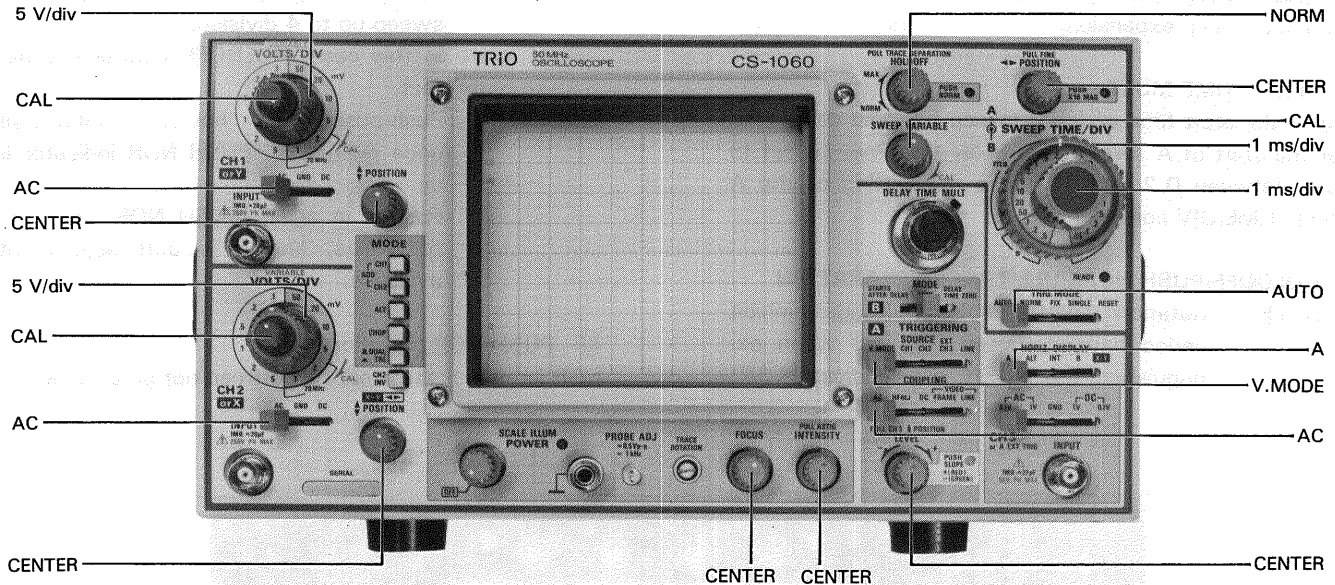


Fig. 6

(1) NORMAL SWEEP DISPLAY OPERATION

1. Turn the POWER switch ⑬ clockwise — the power supply will be turned on and the pilot lamp will light.

Set these modes as follows;

Vertical MODE ⑫ : CH1

TRIG MODE ⑳ : AUTO

2. The trace will appear in the center of the CRT display and can be adjusted by the CH1 \updownarrow POSITION ① and \leftarrow POSITION ⑳ controls. Next, adjust the INTENSITY ⑲ and, if necessary, the FOCUS ⑱ for ease of observation.

3. Vertical Modes

With vertical MODE ⑫ set to CH1, apply an input signal to the CH1 INPUT ⑤ jack and adjust the VOLTS/DIV ② control for a suitable size display of the waveform. If the waveform does not appear in the display, adjust the VOLTS/DIV and \updownarrow POSITION controls to bring the waveform into the center portion of the CRT display. Operation with a signal applied to the CH2 INPUT ⑨ jack and the vertical MODE set to CH2 is similar to the above procedure.

In the ADD mode, the algebraic sum of CH1 + CH2 is displayed. If the CH2 INV ⑩ switch has been engaged, the algebraic difference of the two waveforms, CH1 - CH2 is displayed. If both channels are set to the same VOLTS/DIV, the sum or difference can be read directly in VOLTS/DIV from the CRT.

The DUAL mode allows simultaneous observation of channel 1 and channel 2 waveforms. The TRI mode

allows simultaneous viewing of channel 1 thru channel 3 input signals. In the TRI mode, either the CHOP or ALT mode applies and must be selected.

In the CHOP mode, the sweep is chopped at an approximate 250 kHz rate and switched between CH1 and CH2. Note that in the CHOP mode of operation with the SOURCE switch set to V. MODE, the trigger source becomes the chopping signal itself, making waveform observation impossible. Use ALT mode instead in such cases, or select a trigger SOURCE of CH1, CH2 or CH3. If no trace is obtainable, refer to the following TRIGGERING procedures.

4. After setting the SOURCE switch, adjust the LEVEL/SLOPE control ⑳. The display on the screen will probably be unsynchronized. Refer to TRIGGERING procedure below for adjusting synchronization and sweep speed to obtain a stable display showing the desired number of waveform.

TRIGGERING

The input signal must be properly triggered for stable waveform observation. TRIGGERING is possible using the input signal INTernally to create a trigger or with an EXTerally provided signal of timing relationship to the observed signal, applying such a signal to the EXT TRIG INPUT jack. The SOURCE switch selects the input signal that is to be used to trigger the sweep, with INT sync possibilities (V.MODE, CH1, CH2, LINE) and CH3/EXT sync possibility.

★ Internal Sync

When the SOURCE selection is in INT (V.MODE, CH1, CH2, LINE), the input signal is connected to the internal trigger circuit. In this position, a part of the input signal fed to the INPUT ⑤ or ⑨ jack is applied from the vertical amplifier to the trigger circuit to cause the trigger signal triggered with the input signal to drive the sweep.

When the V.MODE position is selected, the trigger source is dependent upon the vertical MODE selection.

When the vertical MODE switch is selected in ALT and DUAL, the trigger source alternates between channel 1 and channel 2 with each sweep.

When the vertical MODE switch is selected in ALT and TRI, the trigger source alternates channel 1 thru channel 3 with each sweep.

This is convenient for checking amplitudes, waveshape, or waveform period measurements and even permits simultaneous observation of two waveforms which are not related in frequency or period. However, this setting is not suitable for phase or timing comparison measurements. For such measurements, two or three traces must be triggered by the same sync signal.

When the SOURCE selection is in CH1, the input signal at the channel 1 INPUT ⑤ jack becomes trigger regardless of the position of vertical MODE. When the SOURCE selection is in CH2, the input signal at the channel 2 INPUT ⑨ jack becomes trigger regardless of the position of vertical MODE. If the SOURCE switch is set to the LINE position, triggering is derived from the input line voltage (50/60 Hz). This is useful measurements that are related to line frequency.

★ External Sync

When the SOURCE selection is in EXT/CH3, the input signal at the EXT TRIG INPUT ⑭ jack becomes the trigger. This signal must have a time or frequency relationship to the signal being observed to synchronize the display. External sync is preferred for waveform observation in many applications. For example, Fig. 7 shows that the sweep circuit is driven by the gate signal when the gate signal in the burst signal is applied to the EXT TRIG INPUT jack. Fig. 7 also shows the input/output signals, where the burst signal generated from the signal is applied to the instrument under test. Thus, accurate triggering can be achieved without regard to the input signal fed to the INPUT ⑤ or ⑨ jack so that no further triggering is required even when the input signal is varied. When the vertical MODE is set to TRI, triple-trace display is provided and the signal applied to EXT/CH3 is to be used to trigger the sweep, with INTERNAL sync possibility.

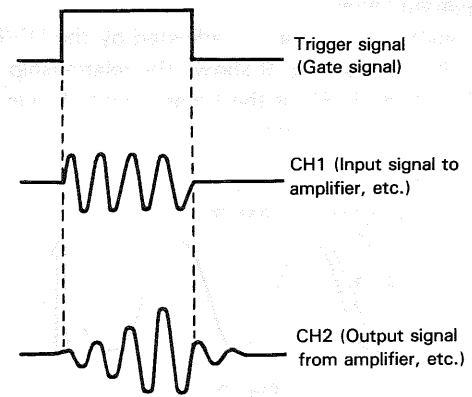


Fig. 7

★ Coupling

The COUPLING switch selects the coupling mode of the trigger signal to the trigger circuit according to the type of trigger signal (DC, AC, signal superimposed on dc, signal with high frequency noise.).

AC:

Most commonly used position; permits triggering from 10 Hz to over 60 MHz (for CS-1040, 40 MHz). Blocks dc component of sync trigger signal.

HFrej.:

Attenuates trigger signal above 100 kHz. Useful to reduce high-frequency noise, and permits triggering from the modulation envelope of an amplitude modulated rf signal.

DC:

Permits triggering from dc to over 60 MHz (for CS-1040, 40 MHz). Couples dc component of sync trigger signal. Useful for triggering from very low frequency signals (below 10 Hz) or ramp waveforms with slow repeating dc.

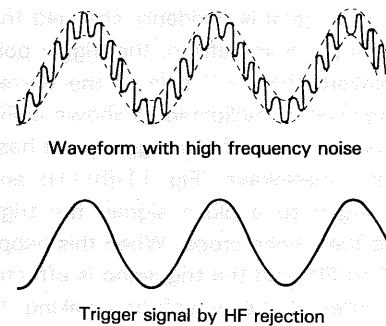


Fig. 8

★ **Triggering Level**

Trigger point on waveform is adjusted by the LEVEL/PUSH SLOPE ⑳ control. Fig. 9 shows the relationship between the SLOPE and LEVEL of the trigger point. Triggering level can be adjusted as necessary.

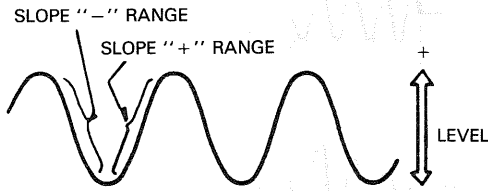


Fig. 9

★ **Auto Trigger**

When the TRIG MODE ㉗ selection is in AUTO, the sweep circuit becomes free-running as long as there is no trigger signal, permitting a check of GND level. When a trigger signal is present, the trigger point can be determined by the LEVEL control for observation as in the normal trigger signal. When the trigger level exceeds the trigger signal, the trigger circuit also becomes free-running where the waveform starts running. When the TRIG MODE is set to NORM and/or, when the trigger signal is absent or the triggering level exceeds the signal there is no sweep.

★ **Fix**

When the TRIG MODE ㉗ is set to FIX, triggering is always effected in the center of the waveform, eliminating the need for adjusting the triggering level. As shown in Fig. 10-(a) or (b), when the TRIG MODE is set to NORM and the triggering level is adjusted to either side of the signal, the trigger point is deviated as the input signal becomes small which, in turn, stops the sweep operation. By setting the TRIG MODE to FIX, the triggering level is automatically adjusted to the approximate center of the waveform and the signal is synchronized regardless of the position of LEVEL control as shown in Fig. 10-(c).

When the input signal is suddenly changed from a square waveform to a pulse waveform, the trigger point is shifted extremely toward the "--" side of the waveform unless the triggering level is readjusted as shown in Fig. 11-(a).

See Fig 11-(a)-(2). Also, if the trigger point has been set to the "--" of squarewave (Fig 11-(b)-(1)) and the input signal is changed to a pluse signal, the trigger point is deviated and the sweep stops. When this happens, set the TRIG MODE to FIX and the triggering is effected in the approximate center of the waveform, making it possible to observe a stabilized waveform. (Fig 11-(c))

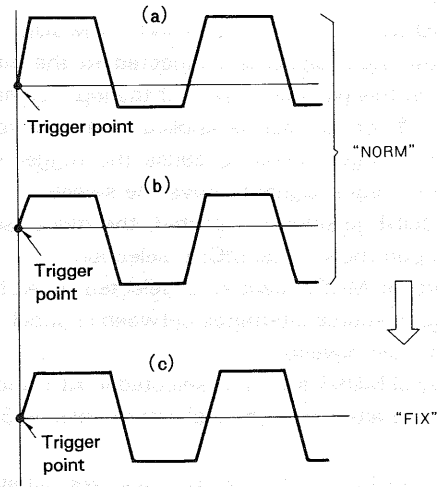
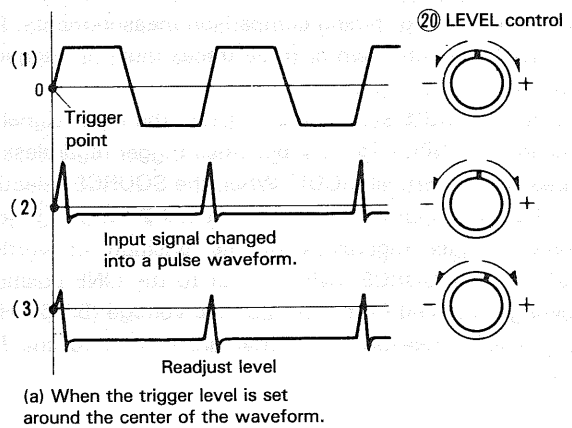
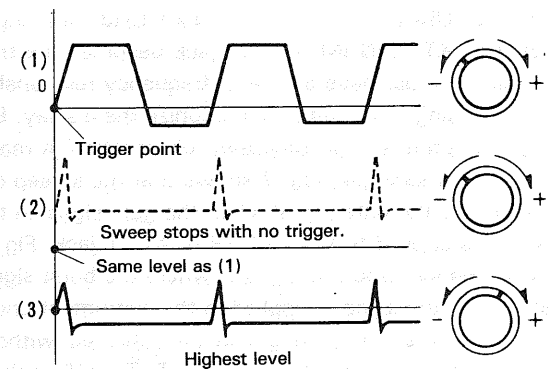


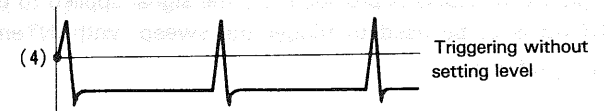
Fig. 10



(a) When the trigger level is set around the center of the waveform.



(b) When the trigger level is set to the "--" side of the waveform (Mode switch set to "NORM")



(c) Mode switch set to "FIX".

Fig. 11

(2) MAGNIFIED SWEEP OPERATION

Since merely shortening the sweep time to magnify a portion of an observed waveform can result in the desired portion disappearing off the screen, such magnified display should be performed using the MAGNIFIED SWEEP.

Using the ◀▶ POSITION control, adjust the desired portion of waveform to the CRT. Push the PUSH×10 MAG control to magnify the display 10 times and ×10 MAG indicator lights. For this type of display the sweep time is the SWEEP TIME/DIV setting divided by 10.

(3) DELAYED SWEEP OPERATION

Delayed sweep operation is achieved by use of both the A sweep and the B sweep.

Procedure:

1. First set the HORIZ DISPLAY to A and adjust for a normal waveform display.
2. Set the B sweep in the STARTS AFTER DELAY mode. Set the HORIZ DISPLAY to the INT mode and the B sweep will appear as an intensified portion of the A sweep. The length of the intensified portion is adjusted by the B SWEEP TIME/DIV control. (Fig. 12)
3. Shift the intensified portion of waveform (section to be magnified) along the A sweep by use of the DELAY TIME MULT ③⑤.
4. Set the HORIZ DISPLAY to B to display the INT intensified portion as a magnified B sweep. (Fig. 13)

Delay Time (magnified portion) = DELAY TIME MULT setting × A SWEEP TIME/DIV setting.

5. For STARTS AFTER DELAY operation, apparent jitter increases as magnification increases. To obtain a jitter free display set the B MODE ②⑧ to TRIG. In this "Triggerable After Delay" mode the A trigger signal selected by the SOURCE switch ②② becomes the B trigger source.

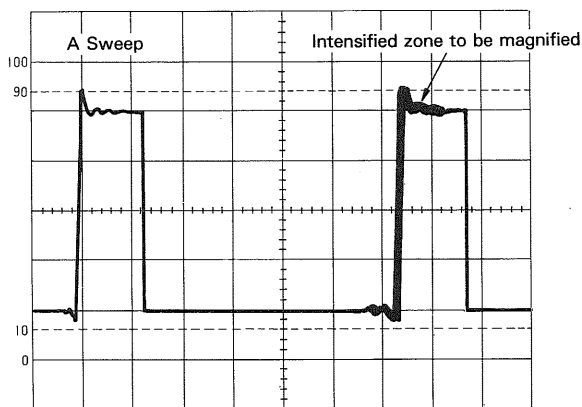


Fig. 12

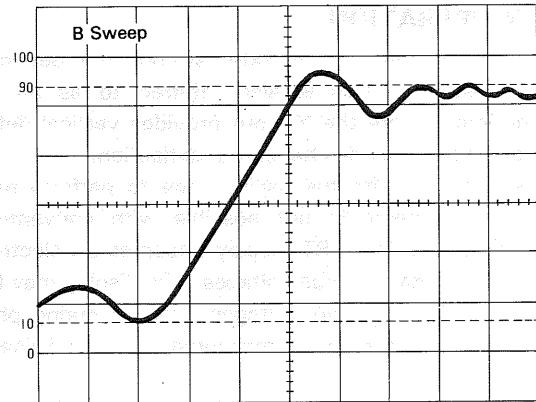


Fig. 13 Magnified view of intensified zone above

Note that for this type of operation both the DELAY TIME MULT and TRIG LEVEL affect the start of the B sweep so that the delay time is used as a reference point. (Fig. 14)

(4) ALTERNATING SWEEP OPERATION

A sweep and B delayed sweep are usable in an alternating fashion making it possible to observe both the normal and magnified waveform simultaneously.

Procedure:

1. Set the HORIZ DISPLAY to A and adjust for a normal waveform display.
2. Set the B MODE to STARTS AFTER DELAY and set the HORIZ DISPLAY to ALT. Adjust TRACE SEPARATION ③⑥ for easy observation of both the A and B traces. The upper trace is the non-magnified portion of the waveform with the magnified portion super-imposed as an intensified section. The lower waveform is the intensified portion displayed magnified.
3. The DELAY TIME MULT can be used to continuously slide the magnified portion of the waveform across the A sweep period to allow magnification of precisely the desired portion of waveform.
4. Apparent display jitter increases with increased magnification as is the case with delayed sweep discussed above.

Set the B MODE to TRIG to obtain a jitter free display the same as delayed sweep operation.

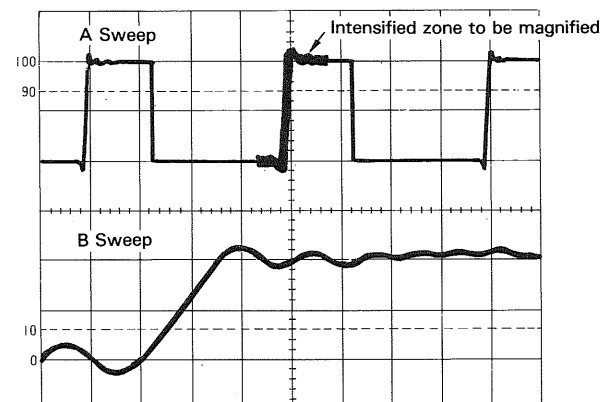


Fig. 14

(5) X-Y OPERATION

For some measurements, an external horizontal deflection signal is required. This is also referred to as an X-Y measurement, where the Y input provides vertical deflection and X input provides horizontal deflection.

X-Y operation permits the oscilloscope to perform many types of measurements not possible with conventional sweep operation. The CRT display becomes an electronic graph of two instantaneous voltages. The display may be a direct comparison of two voltages such as during phase measurement, or frequency measurement with Lissajous waveforms.

To use an external horizontal input, use the following procedure;

1. Set the HORIZ DISPLAY switch to X-Y the position.
2. Use the channel 1 probe for the vertical input and the channel 2 probe for the horizontal input.
3. Adjust the amount of horizontal deflection with the CH2 VOLTS/DIV and VARIABLE controls.
4. The CH2 (vertical) POSITION (11) control now serves as the horizontal position control, and the ◀▶ POSITION control is disabled.
5. All sync controls are disconnected and have no effect.

(6) VIDEO SIGNAL OBSERVATION

The VIDEO FRAME/LINE switch permits selection of vertical or horizontal sync pulse for sweep triggering when viewing composite video waveforms. In the LINE position, horizontal sync pulses are selected as triggers to permit viewing of horizontal line of video. In the FRAME position, vertical sync pulses are selected as triggers to permit viewing of vertical fields and frames of video. When observing the video waveforms, stable display is obtained on the screen regardless the TRIG LEVEL (20) control.

At most points of measurement, a composite video signal is of the (-) polarity, that is, the sync pulses are negative and the video is positive. In this case, use " - " SLOPE.

If the waveform is taken at a circuit point where the video waveform is inverted, the sync pulses are positive and the video is negative. In this case, use " + " SLOPE.

(7) SINGLE SWEEP OPERATION

This mode of display is useful for looking at non-synchronous or one time events.

Procedure:

1. Set the TRIG MODE (27) to either AUTO or NORM. Apply a signal of approximately the same amplitude and frequency as the signal that is to be observed as the trigger signal and set the trigger level.
2. Set TRIG MODE to RESET — observe that the READY indicator LED lights to indicate the reset condition. This LED goes out when the A sweep period is completed.
3. After the above set-up is completed the scope is ready to operate in the SINGLE sweep mode of operation after resetting the instrument using the RESET switch. Input of the trigger signal results in one and only one sweep and READY indicator LED goes out.

CAUTION:

With the HORIZ DISPLAY set to ALT the simultaneous observation of the A sweep and B sweep waveforms at SINGLE sweep mode is not possible. Also for DUAL or TRI operation simultaneous observation is not possible using ALT mode. Set the unit to the CHOP mode in this case.

APPLICATIONS

PROBE COMPENSATION

If accurate measurements are to be made, the effect of the probe being used must be properly adjusted output of the measurement system using the internal calibration signal or some other squarewave source.

1. Connect probe to INPUT jack. Connect ground clip of probe of oscilloscope ground terminal and touch tip of probe to PROBE ADJ terminal.
2. Select single trace operation of channel 1, then channel 2, for step 3 and 4.
For CS-1060, set the probe for 10:1 attenuation (10×position) and VOLTS/DIV to 10mV/div and for CS-1040, set the probe for 10:1 attenuation (10× position).
3. Set oscilloscope controls to display 3 or 4 cycles of PROBE ADJ square wave at 5 or 6 divisions amplitude.
4. Adjust compensation trimmer on probe for optimum square wave waveshape (minimum overshoot, rounding off, and tilt).

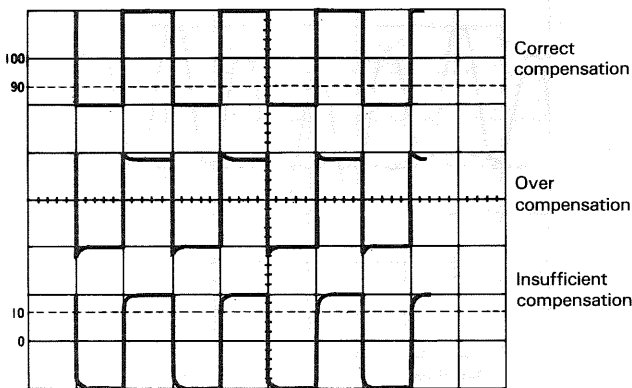


Fig. 15

TRACE ROTATION COMPENSATION

Rotation from a horizontal trace position can be the cause of measurement errors.

Adjust the controls for a single display. Set the AC-GND-DC switch to GND and TRIG MODE to AUTO. Adjust the POSITION control such that the trace is over the center horizontal graticule line. If the trace appears to be rotated from horizontal, align it with the center graticule line using the TRACE ROTATION control located on the front panel.

DC VOLTAGE MEASUREMENTS

This procedure describes the measurement procedure for waveforms including the DC component.

Procedure:

1. Connect the signal to be measured to the INPUT jack. Set the vertical MODE to the channel to be used. Set the VOLTS/DIV and SWEEP TIME/DIV switch to obtain a normal display of the waveform to be measured. Set the VARIABLE control to CAL position.

2. Set the TRIG MODE to AUTO and AC-GND-DC to the GND position, which established the zero volt reference. Using the POSITION control, adjust the trace position to the desired reference level position, making sure not to disturb this setting once made.
3. Set the AC-GND-DC switch to the DC position to observe the input waveform, including its DC component. If an appropriate reference level or VOLTS/DIV setting was not made, the waveform may not be visible on the CRT screen at this point. If so, reset VOLTS/DIV and/or the POSITION control.
4. Use the POSITION control to bring the portion of the waveform to be measured to the center vertical graduation line of the CRT screen.
5. Measure the vertical distance from the reference level to the point to be measured, (the reference level can be rechecked by setting the AC-GND-DC switch again to GND).

Multiply the distance measured above by the VOLTS/DIV setting and the probe attenuation ratio as well. Voltages above and below the reference level are positive and negative values respectively.

Using the formula:

DC level = Vertical distance in divisions × (VOLTS/DIV setting) × (probe attenuation ratio).

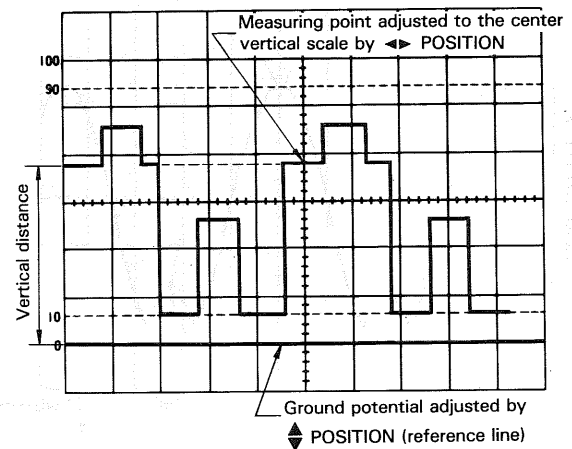


Fig. 16

[EXAMPLE]

For the example, the point being measured is 3.8 divisions from the reference level (ground potential).

If the VOLTS/DIV was set to 0.2 V and a 10:1 probe was used. (See Fig. 16)

Substituting the given values:

$$\text{DC level} = 3.8 (\text{div}) \times 0.2 (\text{V}) \times 10 = 7.6 \text{ V}$$

MEASUREMENT OF THE VOLTAGE BETWEEN TWO POINTS ON A WAVEFORM

This technique can be used to measure peak-to-peak voltages.

Procedure:

1. Apply the signal to be measured to the INPUT jack. Set the vertical MODE to the channel to be used. Set the AC-GND-DC to AC, adjusting VOLTS/DIV and SWEEP TIME/DIV for a normal display. Set the VARIABLE control to CAL position.
2. Using the \blacktriangle POSITION control, adjust the waveform position such that one of the two points falls on a CRT graduation line and that the other is visible on the display screen.
3. Using the \blacktriangleleft POSITION control, adjust the second point to coincide with the center vertical graduation line.
4. Measure the vertical distance between the two points and multiply this by the setting of the VOLTS/DIV control.

If a probe is used, further multiply this by the attenuation ratio.

Using the formula:

$$\text{Volts Peak-to-Peak} = \text{Vertical distance (div)} \times (\text{VOLTS/DIV setting}) \times (\text{probe attenuation ratio})$$

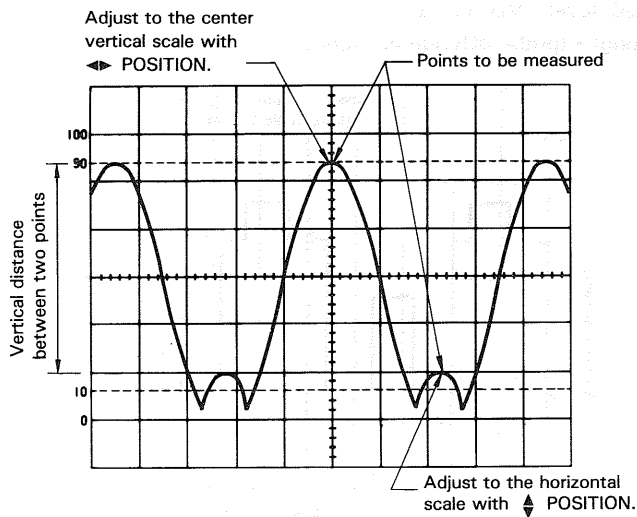


Fig. 17

[EXAMPLE]

For the example, the two points are separated by 4.4 divisions vertically. Set the VOLTS/DIV setting be 0.2 V/div and the probe attenuation be 10:1. (See Fig. 17)

Substituting the given value:

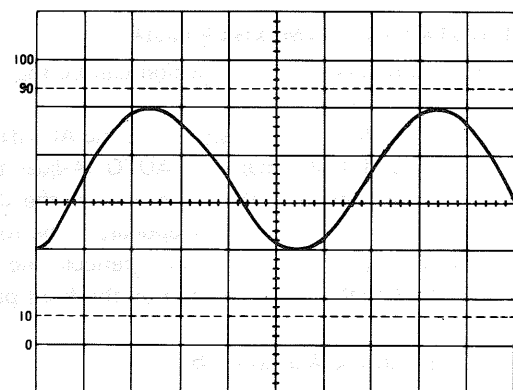
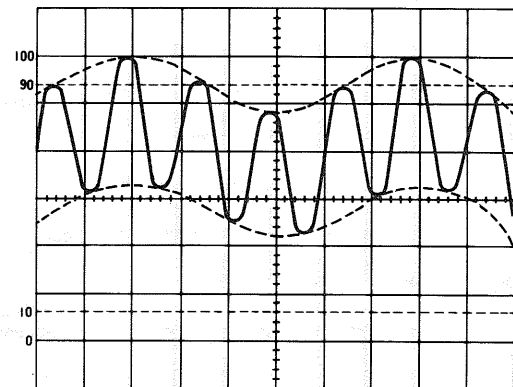
$$\text{Voltage between two points} = 4.4 (\text{div}) \times 0.2(\text{V}) \times 10 = 8.8\text{V}$$

ELIMINATION OF UNDESIRABLE SIGNAL COMPONENTS

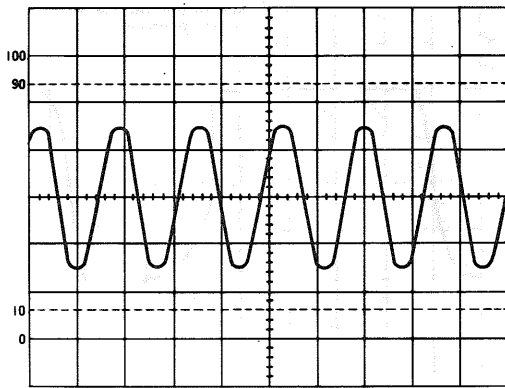
The ADD feature can be conveniently used to cancel out the effect of an undesired signal component which may be superimposed on the signal you wish to observe. (See Fig. 18)

Procedure:

1. Apply the signal containing an undesired component to the CH1 INPUT jack and the undesired signal itself alone to the CH2 INPUT jack.
2. Set the vertical MODE to DUAL (CHOP) and SOURCE to CH2. Verify that CH2 represents the unwanted signal in reverse polarity. If necessary reverse polarity by setting CH2 to INV.
3. Set the vertical MODE to ADD, SOURCE to V. MODE and CH2 VOLTS/DIV and VARIABLE so that the undesired signal component is cancelled as much as possible. The remaining signal should be the signal you wish to observe alone and free of the unwanted signal.



Undesired component signal



Signal without undesired component

Fig. 18

TIME MEASUREMENTS

This is the procedure for making time measurements between two points on a waveform. The combination of the SWEEP TIME/DIV and the horizontal distance in divisions between the two points is used in the calculation.

Procedure:

1. Apply the signal to be measured to the INPUT jack. Set the vertical MODE to the channel to be used. Adjust the VOLTS/DIV and SWEEP TIME/DIV for a normal display. Be sure that the VARIABLE control is set to CAL position.
2. Using the \blacktriangle POSITION control, set one of the points to be used as a reference to coincide with the horizontal centerline. Use the $\blacktriangleleft \blacktriangleright$ POSITION control to set this point at the intersection of any vertical graduation line.
3. Measure the horizontal distance between the two points. Multiply this by the setting of the SWEEP TIME/DIV control to obtain the time between the two points. If horizontal "x 10 MAG" is used, multiply this further by 1/10.

Using the formula:

$$\text{Time} = \text{Horizontal distance (div)} \times (\text{SWEEP TIME/DIV setting}) \times \text{"x 10 MAG" value}^{-1} (1/10)$$

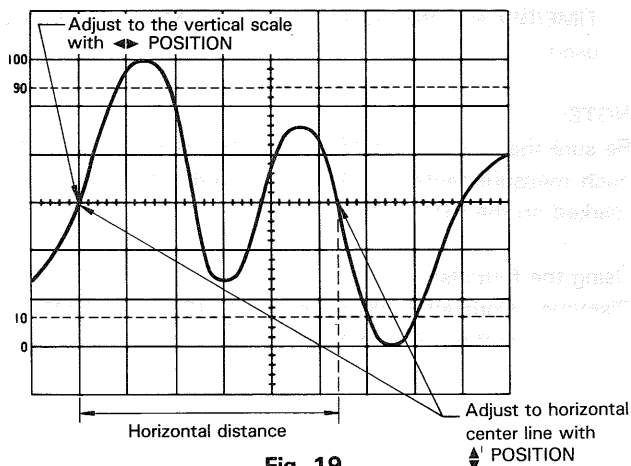


Fig. 19

[EXAMPLE]

For the example, the horizontal distance between the two points is 5.4 divisions.

If the SWEEP TIME/DIV is 0.2 ms/div we calculate. (See Fig. 19)

Substituting the given value:

$$\text{Time} = 5.4 (\text{div}) \times 0.2 (\text{ms}) = 1.08 \text{ ms}$$

FREQUENCY MEASUREMENTS

Frequency measurements are made by measuring the period of one cycle of waveform and taking the reciprocal of this time value as the frequency.

Procedure:

1. Set the oscilloscope up to display one cycle of waveform (one period).
2. The frequency is the reciprocal of the period measured.

Using the formula:

$$\text{Freq} = \frac{1}{\text{period}}$$

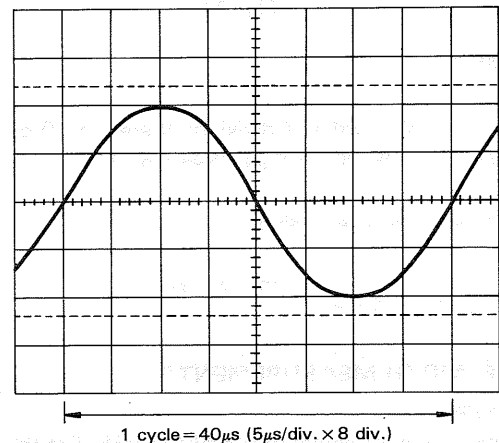


Fig. 20

[EXAMPLE]

A period of 40 μs is observed and measured. (See Fig. 20)

Substituting the given value:

$$\text{Freq} = 1/[40 \times 10^{-6}] = 2.5 \times 10^4 = 25 \text{ kHz}$$

While the above method relies on the measurement directly of the period of one cycle, the frequency may also be measured by counting the number of cycles present in a given time period.

1. Apply the signal to the INPUT jack. Set the vertical MODE to the channel to be used and adjusting the various controls for a normal display. Set the VARIABLE control to CAL position.
2. Count the number of cycles of waveform between a chosen set of vertical graduation lines.

Using the horizontal distance between the vertical lines used above and the SWEEP TIME/DIV, the time span may be calculated. Multiply the reciprocal of this value

by the number of cycles present in the given time span. If "x 10 MAG" is used multiply this further by 10.

Note that errors will occur for displays having only a few cycles.

Using the formula:

$$\text{Freq} = \frac{\# \text{ of cycles} \times \text{"x 10 MAG" value}}{\text{Horizontal distance (div)} \times \text{SWEEP TIME/DIV setting}}$$

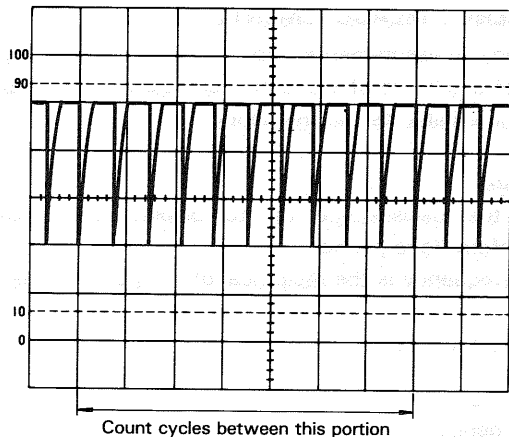


Fig. 21

[EXAMPLE]

For the example, within 7 divisions there are 10 cycles. The SWEEP TIME/DIV is 5 μs. (See Fig. 21)

Substituting the given value:

$$\text{Freq} = \frac{10}{7 \text{ (div)} \times 5 \text{ (}\mu\text{s)}} \approx 285.7 \text{ kHz}$$

PULSE WIDTH MEASUREMENTS

Procedure:

1. Apply the pulse signal to the INPUT jack. Set the vertical MODE to the channel to be used.
2. Use the VOLTS/DIV, VARIABLE and POSITION to adjust the waveform such that the pulse is easily observed and such that the center pulse width coincides with the center horizontal line on the CRT screen.
3. Measure the distance between the intersection of the pulse waveform and the center horizontal line in divisions. Be sure that the VARIABLE control is in the CAL. Multiply this distance by the SWEEP TIME/DIV and by 1/10 if "x 10 MAG" mode is being used.

Using the formula:

$$\text{Pulse width} = \text{Horizontal distance (div)} \times (\text{SWEEP TIME/DIV setting}) \times \text{"x MAG 10" value}^{-1} (1/10)$$

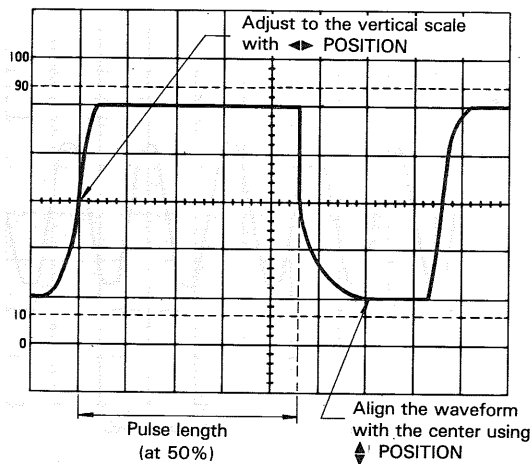


Fig. 22

[EXAMPLE]

For the example, the distance (width) at the center horizontal line is 4.6 divisions and the SWEEP TIME/DIV is 0.2 ms. (See Fig. 22)

Substituting the given value:

$$\text{Pulse width} = 4.6 \text{ (div)} \times 0.2 \text{ ms} = 0.92 \text{ ms}$$

PULSE RISETIME AND FALLTIME MEASUREMENTS

For risetime and falltime measurements, the 10% and 90% amplitude points are used as starting and ending reference points.

Procedure:

1. Apply a signal to the INPUT jack. Set the vertical MODE to the channel to be used. Use the VOLTS/DIV and VARIABLE to adjust the waveform peak-to-peak height to six divisions.
2. Using the POSITION control and the other controls, adjust the display such that the waveform is centered vertically in the display. Set the SWEEP TIME/DIV to as fast a setting as possible consistent with observation of both the 10% and 90% points. Set the VARIABLE control to CAL position.
3. Use the POSITION control to adjust the 10% point to coincide with a vertical graduation line and measure the distance in divisions between the 10% and 90% points on the waveform. Multiply this by the SWEEP TIME/DIV and also by 1/10, if "x 10 MAG" was used.

NOTE:

Be sure that the correct 10% and 90% lines are used. For such measurements the 0, 10, 90 and 100% points are marked on the CRT screen.

Using the formula:

$$\text{Risetime} = \text{Horizontal distance (div)} \times (\text{SWEEP TIME/DIV setting}) \times \text{"x 10 MAG" value}^{-1} (1/10)$$

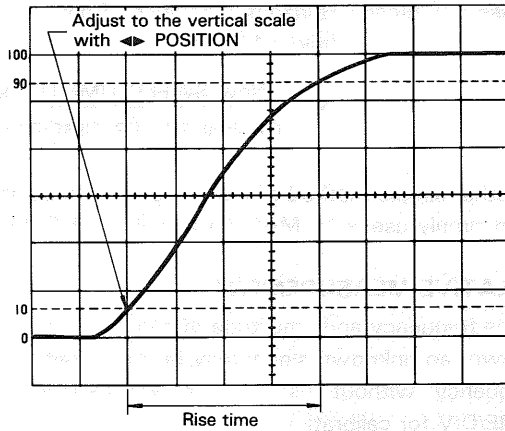


Fig. 23

[EXAMPLE]

For the example, the horizontal distance is 4.0 divisions. The SWEEP TIME/DIV is 2 μ s. (See Fig. 23)

Substituting the given value:

$$\text{Risetime} = 4.0 (\text{div}) \times 2 (\mu\text{s}) = 8\mu\text{s}$$

Risetime and falltime can be measured by making use of the alternate step 3 as described below as well.

- Use the \blacktriangleleft POSITION control to set the 10% point to coincide with the center vertical graduation line and measure the horizontal distance to the point of the intersection of the waveform with the center horizontal line. Let this distance be D_1 . Next adjust the waveform position such that the 90% point coincides with the vertical centerline and measure the distance from that line to the intersection of the waveform with the horizontal centerline. This distance is D_2 and the total horizontal distance is then D_1 plus D_2 for use in the above relationship in calculating the risetime or falltime.

Using the formula:

$$\text{Risetime} = (D_1 + D_2) (\text{div}) \times (\text{SWEEP TIME/DIV setting}) \times \text{"} \times 10 \text{ MAG" value}^{-1} (1/10)$$

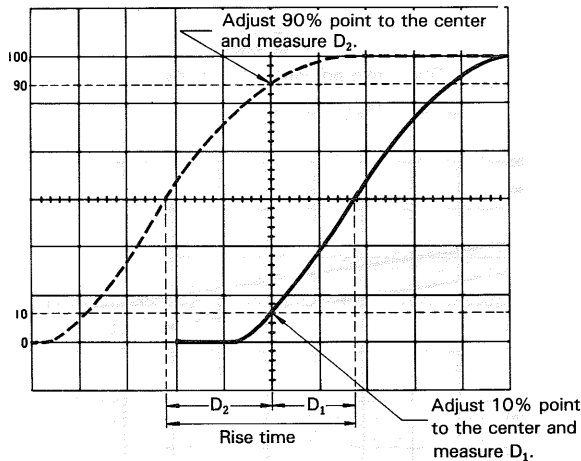


Fig. 24

[EXAMPLE]

For the example, the measured D_1 is 1.8 divisions while D_2 is 2.2 divisions. If SWEEP TIME/DIV is 2 μ s we use the following relationship. (See Fig. 24)

Substituting the given value:

$$\text{Risetime} = (1.8 + 2.2) (\text{div}) \times 2 (\mu\text{s}) = 8 \mu\text{s}$$

TIME DIFFERENCE MEASUREMENTS

This procedure is useful in measurement of time differences between two signals that are synchronized to one another but skewed in time.

Procedure:

- Apply the two signals to CH1 and CH2 INPUT jacks. Set the vertical MODE to DUAL choosing either ALT or CHOP mode. Generally for low frequency signals CHOP is chosen with ALT used for high frequency signals.
- Select the faster of the two signals as the SOURCE and use the VOLTS/DIV and SWEEP TIME/DIV to obtain an easily observed display. Set the VARIABLE control to CAL position.
- Using the \blacktriangle POSITION control set the waveforms to the center of the CRT display and use the \blacktriangleleft POSITION control to set the reference signal to be coincident with a vertical graduation line.
- Measure the horizontal distance between the two signals and multiply this distance in divisions by the SWEEP TIME/DIV setting. If "x10 MAG" is being used multiply this again by 1/10.

Using the formula:

$$\text{Time} = \text{Horizontal distance (div)} \times (\text{SWEEP TIME/DIV setting}) \times \text{"} \times 10 \text{ MAG" value}^{-1} (1/10)$$

[EXAMPLE]

For the example, the horizontal distance measured is 4.4 divisions. The SWEEP TIME/DIV is 0.2 ms. (See Fig. 25)

Substituting the given value:

$$\text{Time} = 4.4 (\text{div}) \times 0.2 (\text{ms}) = 0.88 \text{ ms}$$

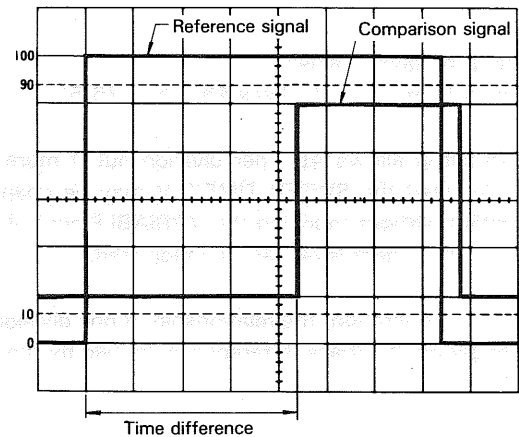


Fig. 25

PHASE DIFFERENCE MEASUREMENTS

This procedure is useful in measuring the phase difference of signals of the same frequency.

Procedure:

1. Apply the two signals to the CH1 and CH2 INPUT jacks, setting the vertical MODE to either CHOP or ALT mode.
2. Set the SOURCE to the signal which is leading in phase and use the VOLTS/DIV to adjust the signals such that they are equal in amplitude. Adjust the other controls for a normal display.

3. Use the SWEEP TIME/DIV and SWEEP VARIABLE to adjust the display such that one cycle of the signals occupies 8 divisions of horizontal display.

Use the \blacktriangle POSITION to bring the signals in the center of the screen.

Having set up the display as above, one division now represents 45° in phase.

4. Measure the horizontal distance between corresponding points on the two waveforms.

Using the formula:

$$\text{Phase difference} = \text{Horizontal distance (div)} \times 45^\circ/\text{div}$$

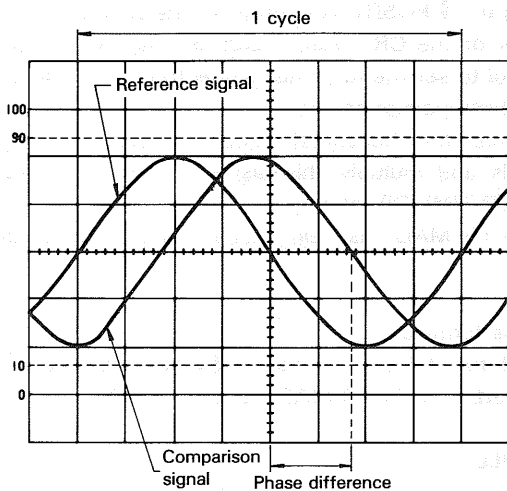


Fig. 26

[EXAMPLE]

For the example, the horizontal distance is 1.7 divisions. (See Fig. 26)

Substituting the given value:

$$\text{The phase difference} = 1.7 (\text{div}) \times 45^\circ/\text{div} = 76.5^\circ$$

The above setup allows 45° per division but if more accuracy is required the SWEEP TIME/DIV may be changed and magnified without touching the VARIABLE control and if necessary the trigger level can be readjusted.

For this type of operation, the relationship of one division to 45° no longer holds. Phase difference is defined by the formula as follows.

$$\text{Phase difference} = \text{Horizontal distance of new sweep range (div)} \times 45^\circ/\text{div}$$

$$\times \frac{\text{New SWEEP TIME/DIV setting}}{\text{Original SWEEP TIME/DIV setting}}$$

Another simple method of obtaining more accuracy quickly is to simply use $\times 10$ MAG for a scale of $4.5^\circ/\text{div}$.

RELATIVE MEASUREMENT

If the frequency and amplitude of some reference signal are known, an unknown signal may be measured for level and frequency without use of the VOLTS/DIV or SWEEP TIME/DIV for calibration.

The measurement is made in units relative to the reference signal.

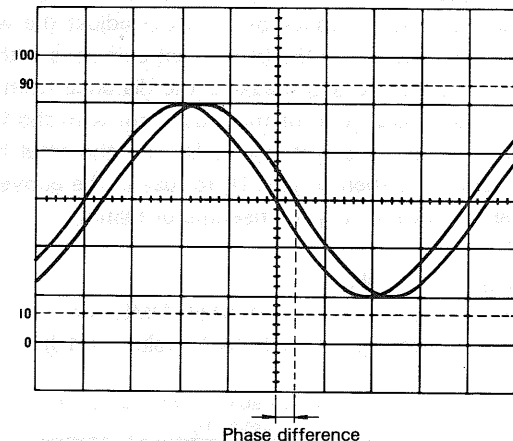
★ Vertical Sensitivity

Setting the relative vertical sensitivity using a reference signal.

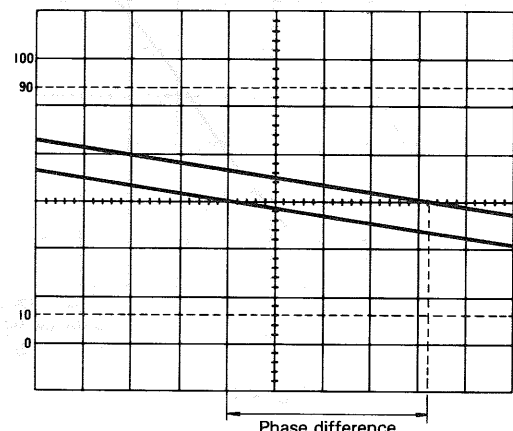
Procedure:

1. Apply the reference signal to the INPUT jack and adjust the display for a normal waveform display.

Adjust the VOLTS/DIV and VARIABLE so that the signal coincides with the CRT face's graduation lines. After adjusting, be sure not to disturb the setting of the VARIABLE control.



One cycle adjusted to occupy 8 div.



Expanded sweep waveform display.

Fig. 27

- The vertical calibration coefficient is now the reference signal's amplitude (in volts) divided by the product of the vertical amplitude set in step 1 and the VOLTS/DIV setting.

Using the formula:

$$\text{Vertical coefficient} = \frac{\text{Voltage of the reference signal (V)}}{\text{Vertical amplitude (div)} \times \text{VOLTS/DIV setting}}$$

- Remove the reference signal and apply the unknown signal to the INPUT jack, using the VOLTS/DIV control to adjust the display for easy observation. Measure the amplitude of the displayed waveform and use the following relationship to calculate the actual amplitude of the unknown waveform.

Using the formula:

$$\text{Amplitude of the unknown signal (V)} = \text{Vertical distance (div)} \times \text{Vertical coefficient} \times \text{VOLTS/DIV setting}$$

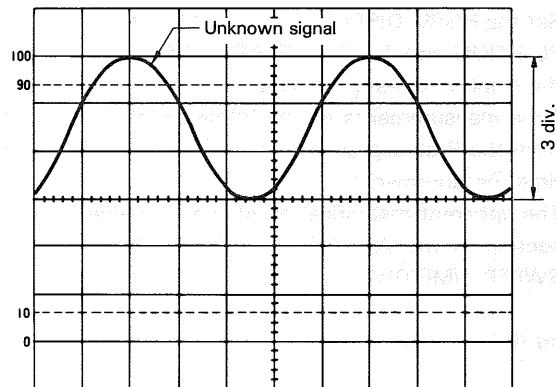
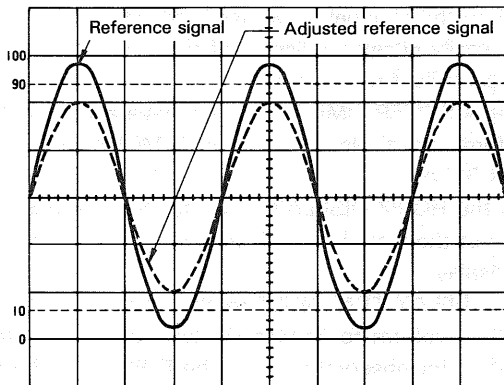


Fig. 28

[EXAMPLE]

For the example, the VOLTS/DIV is 1 V. The reference signal is 2 Vrms. Using the VARIABLE, adjust so that the amplitude of the reference signal is 4 divisions. (See Fig. 28)

Substituting the given value:

$$\text{Vertical coefficient} = \frac{2 \text{ Vrms}}{4 \text{ (div)} \times 1 \text{ (V)}} = 0.5$$

Then measure the unknown signal and VOLTS/DIV is 5 V and vertical amplitude is 3 divisions.

Substituting the given value:

$$\text{Effective value of unknown signal} = 3 \text{ (div)} \times 0.5 \times 5 \text{ (V)} = 7.5 \text{ V rms}$$

★ Period

Setting the relative sweep coefficient with respect to a reference frequency signal.

Procedure:

- Apply the reference signal to the INPUT jack, using the VOLTS/DIV and VARIABLE to obtain an easily observed waveform display. Using the SWEEP TIME/DIV and SWEEP VARIABLE adjust one cycle of the reference signal to occupy a fixed number of scale divisions accurately. After this is done be sure not to disturb the setting of the VARIABLE control.
- The Sweep (horizontal) calibration coefficient is then the period of the reference signal divided by the product of the number of divisions used in step 1 for setup of the reference and the setting of the SWEEP TIME/DIV control.

Using the formula:

$$\text{Sweep coefficient} = \frac{\text{Period of the reference signal (sec)}}{\text{horizontal width (div)} \times \text{SWEEP TIME/DIV setting}}$$

- Remove the reference signal and input the unknown signal, adjusting the SWEEP TIME/DIV control for easy observation. Measure the width of one cycle in divisions and use the following relationship to calculate the actual period.

Using the formula:

$$\text{Period of unknown signal} = \text{Width of 1 cycle (div)} \times \text{sweep coefficient} \times \text{SWEEP TIME/DIV setting}$$

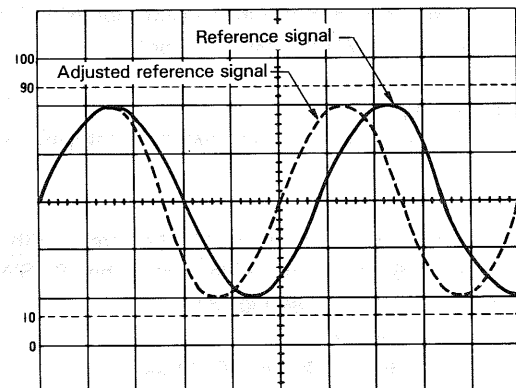


Fig. 29

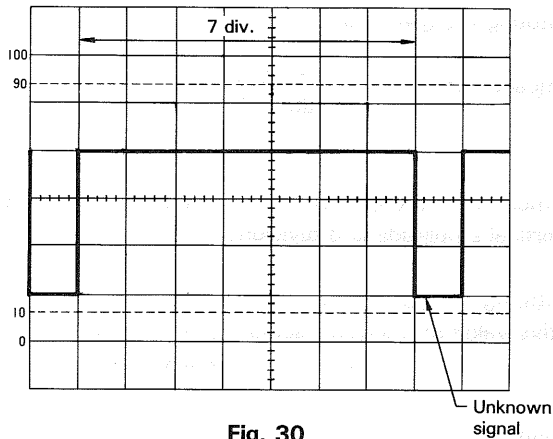


Fig. 30

[EXAMPLE]

SWEEP TIME/DIV is 0.1 ms and apply 1.75 kHz reference signal. Adjust the SWEEP VARIABLE so that the distance of one cycle is 5 divisions.

Substituting the given value:

$$\text{Horizontal coefficient} = \frac{1.75 \text{ (kHz)}^{-1}}{5 \times 0.1 \text{ (ms)}} = 1.142$$

Then, SWEEP TIME/DIV is 0.2 ms and horizontal amplitude is 7 divisions. (See Fig. 30)

Substituting the given value:

$$\text{Pulse width} = 7 \text{ (div)} \times 1.142 \times 0.2 \text{ (ms)} \approx 1.6 \text{ ms}$$

PULSE JITTER MEASUREMENT

1. Apply the signal to the INPUT jack and set the vertical MODE to the channel to be used. Use the VOLTS/DIV to adjust for an easy to observe waveform display. Special care should be taken to adjust the trigger group of controls for a stable display. Set the SWEEP VARIABLE to CAL position.
2. Set the HORIZ DISPLAY to INT and B MODE to affect the STARTS AFTER DELAY mode. Adjust the DELAY TIME MULT for intensified display of the waveform to be measured.
3. Using the B SWEEP TIME/DIV adjust the display for intensification of the entire jitter area of the waveform.
4. Set the HORIZ DISPLAY to B. Measure the width of the jitter area. The jitter time is this width in division multiplied by the setting of the B SWEEP TIME/DIV control.

Using the formula:

$$\text{Pulse jitter} = \text{Jitter width (div)} \times \text{B SWEEP TIME/DIV setting}$$

[EXAMPLE]

The example shows a case in which the jitter width was measured at 1.6 divisions wide with the B SWEEP TIME/DIV set at 0.2 μs. (See Fig. 31)

Substituting the given value:

$$\text{Pulse jitter} = 1.6 \text{ (div)} \times 0.2 \text{ (}\mu\text{s)} = 0.32 \text{ }\mu\text{s}$$

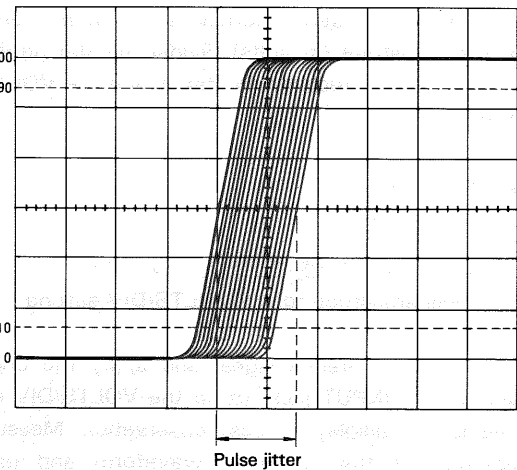


Fig. 31

SWEEP MULTIPLICATION (MAGNIFICATION)

The apparent magnification of the delayed sweep is determined by the values set by the A and B SWEEP TIME/DIV controls.

1. Apply a signal to the INPUT jack and set the vertical MODE to the channel to be used, adjusting VOLTS/DIV for an easily observed display of the waveform and the other controls if necessary.
2. Set the A SWEEP TIME/DIV so that several cycles of the waveform are displayed. Set the B MODE to STARTS AFTER DELAY. When the HORIZ DISPLAY is set to INT, the magnified portion of the waveform will appear intensified on the CRT display.
3. Use the DELAY TIME MULT to shift the intensified portion of waveform to correspond with the section to be magnified for observation. Use the B SWEEP TIME/DIV to adjust intensified portion to cover the entire portion to be magnified.
4. Set the HORIZ DISPLAY to either ALT or B and use the POSITION and TRACE SEPARATION controls to adjust the display for easy viewing.
5. Time measurements are performed in the same manner from the B sweep as was described above for A sweep time measurements.

The apparent magnification of the intensified waveform section is the A SWEEP TIME/DIV divided by the B SWEEP TIME/DIV.

Using the formula:

$$\text{The apparent magnification of the intensified waveform} = \frac{\text{A SWEEP TIME/DIV setting}}{\text{B SWEEP TIME/DIV setting}}$$

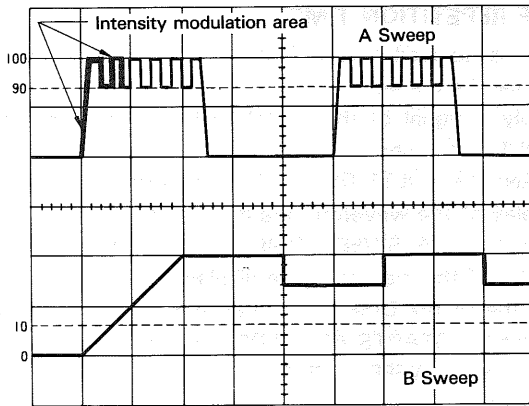


Fig. 32

[EXAMPLE]

In the example, the A SWEEP TIME is 2 μ s and the B SWEEP TIME is 0.2 μ s. (See Fig. 32)

Substituting the given value:

$$\text{Apparent magnification ratio} = \frac{2 \times 10^{-6}}{0.2 \times 10^{-6}} = 10$$

With the above magnification, if the magnification ratio is increased, delay jitter will occur.

To achieve a stable display, set the B MODE to TRIG and used the triggered mode of operation.

1. Perform the above steps 1 through 3.
2. Set the B MODE to TRIG.
3. Set the HORIZ DISPLAY to either ALT or B. The apparent magnification will be the same as described above.

DELAYED SWEEP TIME MEASUREMENT

Using the B sweep, high accuracy time measurements can be made.

1. Apply a signal to INPUT jack and set the vertical MODE to the channel to be used. Adjust the VOLTS/DIV and the other controls if necessary to obtain an easily observed waveform display.
Set the SWEEP VARIABLE to CAL position.
2. Adjust the A SWEEP TIME/DIV to display the portion of waveform to be measured. Set the B MODE to STARTS AFTER DELAY mode.
Set the HORIZ DISPLAY to INT and adjust the B SWEEP TIME/DIV for as small as possible an intensified region.
3. Using the POSITION control adjust the waveform position so as to intersect with the center horizontal line on the CRT screen. Use the DELAY TIME MULT so that the intensified portion of waveform touches the center horizontal line and record the setting of the DELAY TIME MULT at this point.
4. Use the DELAY TIME MULT to adjust intensified portion to same point of the second waveform.
The waveform period is the second dial reading minus the first dial reading multiplied by the A SWEEP TIME/DIV setting.

Using the formula:

$$\text{Period} = (2\text{nd dial reading} - 1\text{st dial reading}) \times \text{Delayed sweep time (A SWEEP TIME/DIV setting)}$$

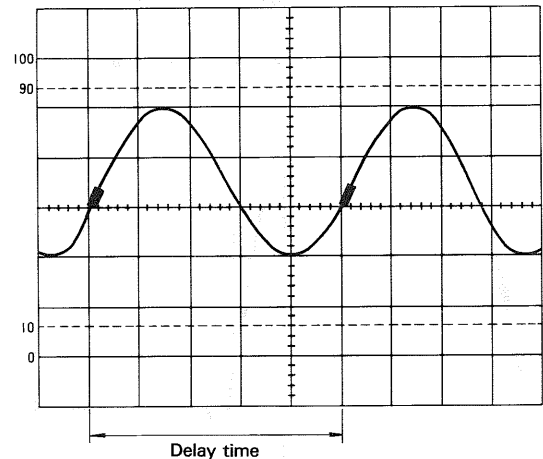


Fig. 33

[EXAMPLE]

For the example the first dial setting is 1.01 and the second is 6.04. The setting of A SWEEP TIME/DIV is 2 ms. (See Fig. 33)

Substituting the given value:

$$\text{Period} = (6.04 - 1.01) \times 2 \text{ (ms)} = 10.06 \text{ ms}$$

PULSE WIDTH MEASUREMENTS USING DELAYED SWEEP

This method is similar to the time measurement method and can be used for high accuracy pulse width measurements.

1. Apply the pulse signal to the INPUT jack and set the vertical MODE to the channel to be used.
2. Use the VOLTS/DIV, VARIABLE and POSITION controls to adjust the display such that the waveform is easily observable with the center of the pulse width coinciding with the center horizontal graduation line.
Set the SWEEP VARIABLE to CAL position.
3. Set the A SWEEP TIME/DIV to display the portion of the waveform to be measured, set the B MODE to TRIG.
Set the HORIZ DISPLAY to INT, and adjust the B SWEEP TIME/DIV for as short as possible an intensified section of waveform.
4. Using the DELAY TIME MULT, adjust the display so that the intensified portion touches the center horizontal graduation line of the CRT screen and record the dial setting at this point.
5. Using the DELAY TIME MULT adjust the falling edge of the pulse so that it touches the center horizontal graduation line and is intensified.
The pulse width is the second dial reading minus the first dial reading multiplied by the A SWEEP TIME/DIV setting.

Using the formula:

$$\text{Pulse width} = (2\text{nd dial reading} - 1\text{st dial reading}) \times \text{Delayed sweep time (A SWEEP TIME/DIV setting)}$$

[EXAMPLE]

In the example, the first dial reading is 0.61 and the second is 5.78 with the A SWEEP TIME/DIV setting at 2 μs. Substituting the appropriate values. (See Fig. 34)

$$\text{Pulse width} = (5.78 - 0.61) \times 2 (\mu\text{s}) = 10.34 \mu\text{s}$$

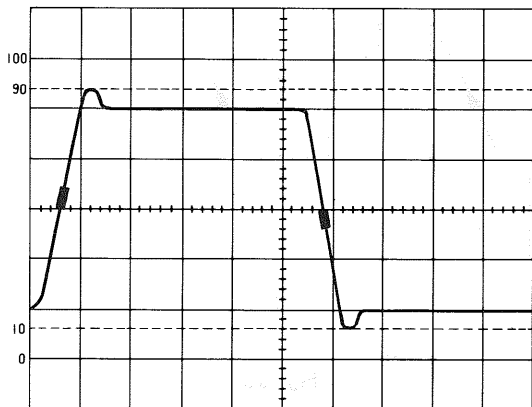


Fig. 34

FREQUENCY MEASUREMENTS USING DELAYED SWEEP

The frequency is obtained as the reciprocal of the period of one cycle.

1. Measure the period of the waveform using the procedure described above for time measurement.
2. The frequency is then the reciprocal of the period measured.

Using the formula:

$$\text{Freq} = \frac{1}{\text{Period}}$$

[EXAMPLE]

For the example, the period measured is 40.2 μs, making the frequency simply. (See Fig. 35)

Substituting the given value:

$$\text{Freq} = 1/(40.2 \times 10^{-6}) \approx 24.88 \text{ kHz}$$

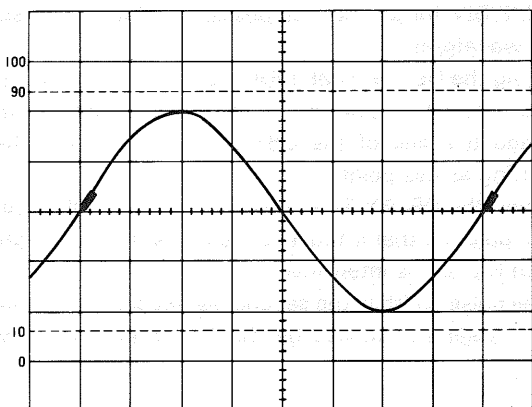


Fig. 35

PULSE REPETITION TIME

Using the delayed sweep feature, reliable time measurements can be made.

1. Apply a signal to the INPUT jack and set the vertical MODE to the channel to be used. Adjust the VOLTS/DIV to obtain a normal easy to view display of the waveform are displayed.
2. Adjust the A SWEEP TIME/DIV so that at least two cycles of the waveform are displayed. Set the HORIZ DISPLAY to INT and set the B MODE to affect the STARTS AFTER DELAY mode of operation. Set the B SWEEP TIME/DIV as fast a sweep speed as possible.
3. Using the DELAY TIME MULT, adjust the intensified portion to coincide with the first pulse. Set the HORIZ DISPLAY to ALT and use TRACE SEPARATION to adjust the waveforms for easy viewing.
4. Using the DELAY TIME MULT, set the pulse to coincide with one of the vertical graduation lines and record the dial setting at this point.
5. Again using the DELAY TIME MULT, adjust the second pulse in the same manner to the vertical line used in step 4, recording this dial setting as well. The pulse repetition time is the second dial reading minus the first dial reading multiplied by the A SWEEP TIME/DIV control setting.

Using the formula:

$$\text{Pulse repetition time} = (2\text{nd dial reading} - 1\text{st dial reading}) \times \text{Delayed sweep time (A SWEEP TIME/DIV setting)}$$

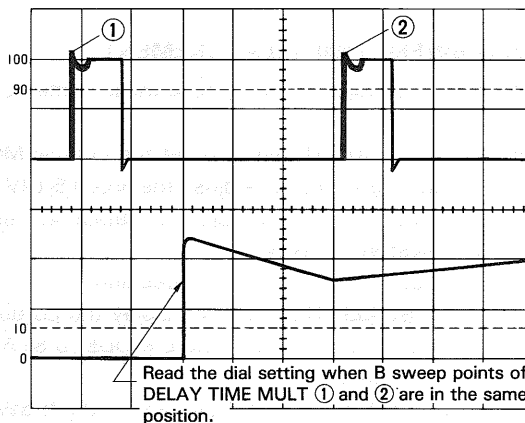


Fig. 36

[EXAMPLE]

For the example, the first dial reading is 0.76 and the second is 6.22 with the A SWEEP TIME/DIV set at 2 μs. We have, substituting the appropriate values. (See Fig. 36)

$$\text{Pulse repetition time} = (6.22 - 0.76) \times 2 (\mu\text{s}) = 10.92 \mu\text{s}$$

USING DELAYED SWEEP FOR MEASUREMENT OF RISETIMES AND FALLTIMES

Risetimes and falltimes are generally measured by using the 10% and 90% amplitude points as reference starting and ending points for the rise or fall.

1. Apply the signal to the INPUT jack and set the vertical MODE to the channel to be used.

Use the VOLTS/DIV and VARIABLE controls to obtain a normal 6 divisions vertical amplitude waveform.

Using the \blacktriangledown POSITION control, set the waveform position in the central area of the screen vertically, that it to coincide with the 100% and 0% lines on the CRT screen.

Set the SWEEP TIME/DIV control to as high a speed as possible consistent with observatin of both the 10% and 90% points.

Set the SWEEP VARIABLE to CAL position.

2. Set the B MODE to initiate the STARTS AFTER DELAY mode of operation and HORIZ DISPLAY to INT and adjust the B SWEEP TIME/DIV for as short as possible an intensified section of waveform.
3. Using the DELAY TIME MULT, adjust the waveform such that the 10% point is intensified and record the dial reading.
4. Similarly, using the DELAY TIME MULT, adjust the 90% point so that it is intensified and record that dial reading as well.

The pulse risetime (or falltime) is simply the difference between the two dial settings times the A SWEEP TIME/DIV control setting.

Using the formula:

Risetime = (2nd dial reading - 1st dial reading) \times Delayed sweep time (A SWEEP TIME/DIV setting)

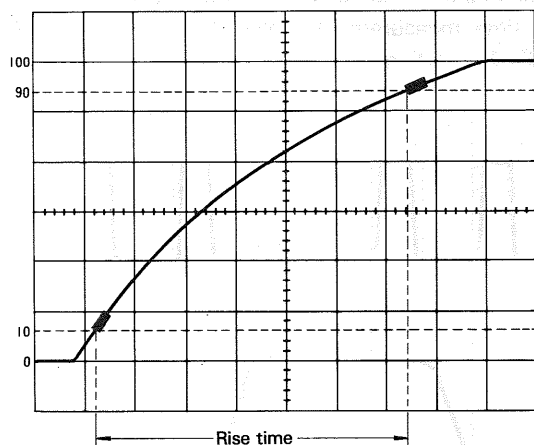


Fig. 37

[EXAMPLE]

For the example, the first dial reading is 1.20 (10% point) and the second is 7.38 (90% point) with the A SWEEP TIME/DIV set at 2 μ s. (See Fig. 37)

Substituting the given value:

$$\text{Risetime} = (7.38 - 1.20) \times 2 (\mu\text{s}) = 12.36 \mu\text{s}$$

TIME DIFFERENCE MEASUREMENTS USING DELAYED SWEEP

Synchronized waveforms which are skewed in time can be accurately measured using the delayed sweep.

1. Apply the two signals to the CH1 and CH2 INPUT jacks setting the vertical MODE to DUAL and selecting either ALT or CHOP display.
2. Set the SOURCE to the signal that is leading in phase and adjust VOLTS/DIV and SWEEP TIME/DIV for easy waveform observation.
Set the SWEEP VARIABLE control to CAL position.
3. Set the B MODE to initiate the STARTS AFTER DELAY mode of operation. Set the HORIZ DISPLAY to INT and adjust the B SWEEP TIME/DIV and DELAY TIME MULT to make the intensified portion coincide with the rising edge or falling edge of the waveform that is to be used as the reference.
4. Set the HORIZ DISPLAY to ALT and use the TRACE SEPARATION control to adjust the B sweep for easy observation.
5. Using the DELAY TIME MULT adjust the pulse to any convenient vertical graduation line and record the dial reading at that point.
6. Using the DELAY TIME MULT adjust the corresponding point on the second signal to the same vertical line and record the reading of the dial at this point as well. The time difference or skew of the two waveforms is then the second dial reading minus the first dial reading multiplied by the A SWEEP TIME/DIV control setting.

Using the formula:

Time difference = (2nd dial reading - 1st dial reading) \times Delayed sweep time (A SWEEP TIME/DIV setting).

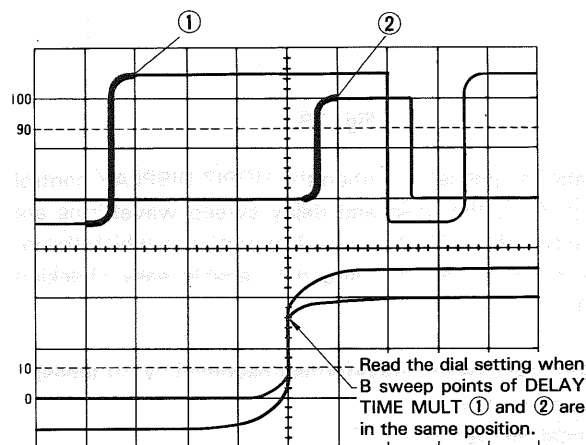


Fig. 38

[EXAMPLE]

The reference signal dial reading is 1.00 while the second dial reading is 5.34 with an A SWEEP TIME/DIV setting of 2 μ s. (See Fig. 38)

Substituting the value:

$$\text{Time difference} = (5.34 - 1.00) \times 2 (\mu\text{s}) = 8.68 \mu\text{s}$$

TRIPLE-TRACE APPLICATIONS

The sensitivities of channel 1 thru channel 3 are calibrated and each channel has 60 MHz band width. (For CS-1040, 40 MHz) The trigger signal of channel 3 can be obtained from its preamplifier.

This unit can be used not only for external synchronization but also for checking triple-trace at a time.

Application

1. Checking logic signal timing.
2. Monitoring video signals.
3. Measuring audio signal gain and phase characteristics.

The details of the logic signal timing checking are described below.

Logic signal timing indication

Control setting
 Vertical MODE: TRI, ALT
 HORIZ DISPLAY: A
 SOURCE: CH3

To obtain stable synchronization, synchronize with the longest period channel (in this case, CH3).

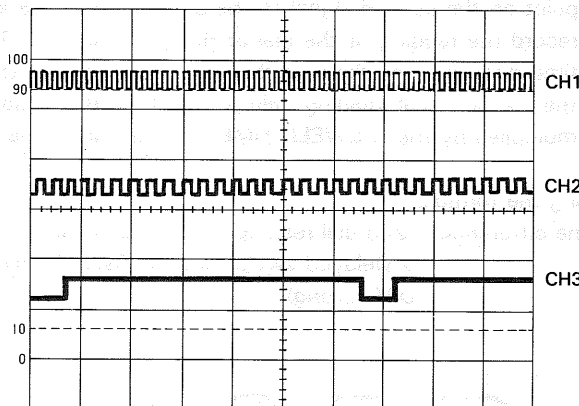


Fig. 39

In the above application, when the HORIZ DISPLAY control is set to ALT, the main and delay sweep waveforms are displayed on the CRT at a time. The portion in which the intensity is modulated is enlarged to enable easy checking Fig. 40.

Main and delay sweep waveforms (magnified by 10 times)

Control setting
 Vertical MODE: TRI, ALT
 SOURCE: CH3
 HORIZ DISPLAY: ALT
 B MODE: STARTS AFTER DELAY

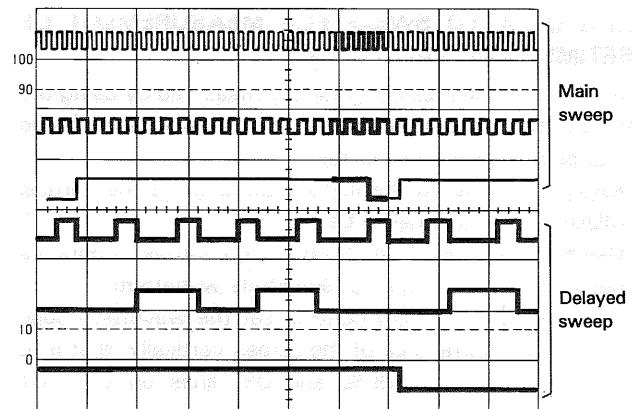


Fig. 40

OBSERVATION OF THE START PORTION OF THE IRREGULAR WAVEFORM

To observe the start portion of the irregular waveform, magnification of the start portion of the waveform can be made with the DELAY TIME ZERO.

Procedure;

1. Apply the signal to INPUT jack and set the vertical MODE to the channel to be used and adjusting the various controls for a normal display.
2. Use the A SWEEP TIME/DIV and HOLDOFF controls to adjust the display such that a number of cycles of waveform is observed. Next, set the B MODE to TRIG.
3. Set the HORIZ DISPLAY to ALT or B and use the POSITION and TRACE SEPARATION controls to adjust the display such that the display is easily observed.
4. The observation of the start portion of the waveform can be made to set the B SWEEP TIME/DIV to as fast a setting as possible consistent with observation. For time measurement, calculate from the B SWEEP TIME/DIV setting.

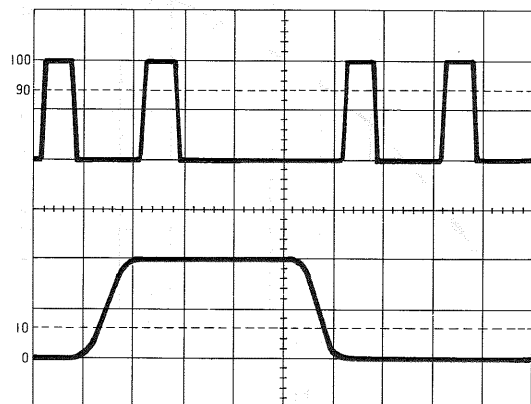


Fig. 41

X-Y APPLICATIONS

★ Phase Shift Measurement

A method of phase measurement requires calculations based on the Lissajous patterns obtained using X-Y operations. Distortion due to non-linear amplification also can be displayed.

A sine wave input is applied to the audio circuit being tested. The same sine wave input is applied to the vertical input of the oscilloscope, and the output of the tested circuit is applied to the horizontal input of the oscilloscope. The amount of phase difference between the two signals can be calculated from the resulting waveform.

To make phase measurements, use the following procedure.

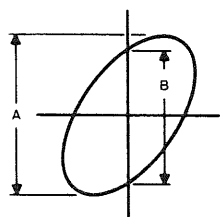
1. Using an audio signal generator with a pure sinusoidal signal, apply a sine wave test signal at the desired test frequency to the audio network being tested.
2. Set the signal generator output for the normal operating level of the circuit being tested. If desired, the circuit's output may be observed on the oscilloscope. If the test circuit is overdriven, the sine wave display on the oscilloscope is clipped and the signal level must be reduced.
3. Connect the channel 2 probe to the output of the test circuit.
4. Select X-Y operation by placing the HORIZ DISPLAY switch in the X-Y position.
5. Connect the channel 1 probe to the input of the test circuit.

(The input and output test connections to the vertical and horizontal oscilloscope inputs may be reserved.)

6. Adjust the channel 1 and 2 gain controls for a suitable viewing size.
7. Some typical results are shown in Fig. 43.

If the two signals are in phase, the oscilloscope trace is a straight diagonal line. If the vertical and horizontal gain are properly adjusted, this line is at a 45° angle. A 90° phase shift produces a circular oscilloscope pattern.

Phase shift of less (or more) than 90° produces an elliptical oscilloscope pattern. The amount of phase shift can be calculated from the oscilloscope trace as shown in Fig. 42.



$$\text{SINE } \phi = \frac{B}{A}$$

Where ϕ = phase angle

Fig. 42 Phase shift calculation

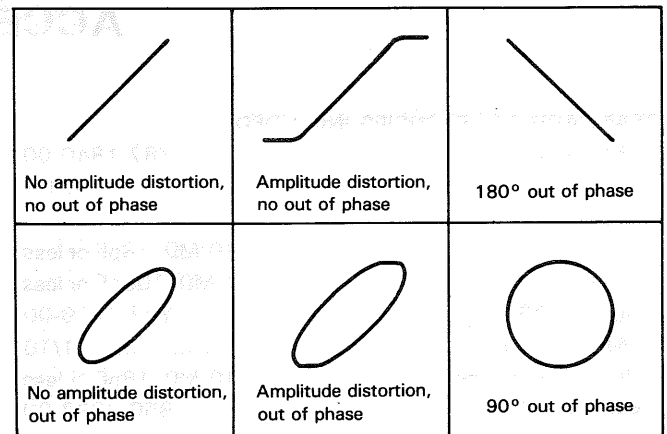


Fig. 43 Typical phase measurement oscilloscope display

★ Frequency Measurement

1. Connect the sine wave of known frequency to the channel 2 INPUT jack of the oscilloscope and select X-Y operation. This provides external horizontal input.
2. Connect the vertical input probe (CH1 INPUT) to the unknown frequency.
3. Adjust the channel 1 and 2 size controls for convenient, easy-to-read size of display.
4. The resulting pattern, called a Lissajous pattern, shows the ratio between the two frequencies.

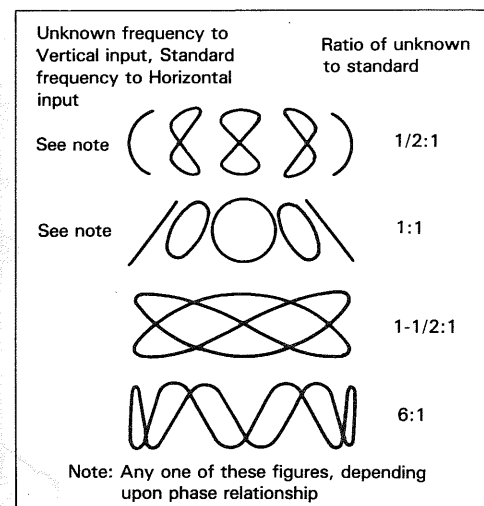


Fig. 44 Lissajous waveforms used for frequency measurement

ACCESSORIES

STANDARD ACCESSORIES INCLUDED

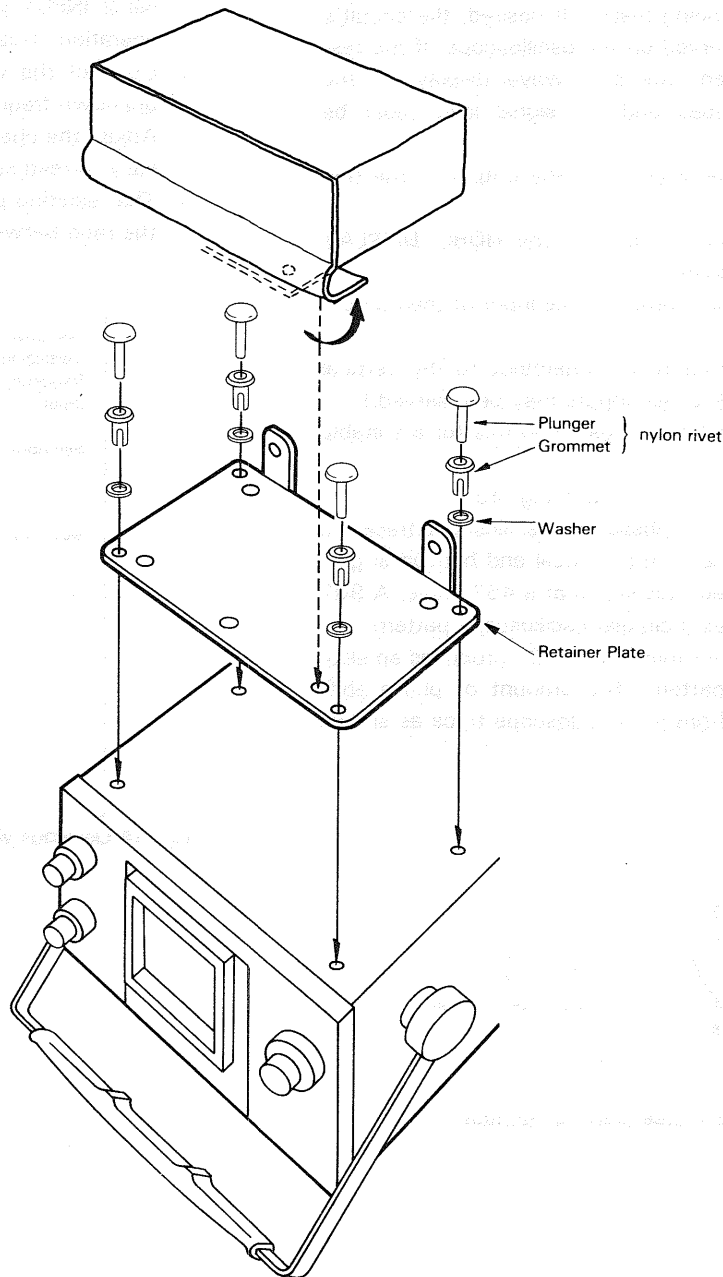
Probe (PC-20)	Y87-1840-00
Attenuation.....	1/10, 1/1
Input Impedance	
1/10	10 M Ω , 18pF or less
1/1	1 M Ω , 100pF or less
Probe (PC-29)	Y87-1250-00
Attenuation	1/10
Input Impedance.....	10 M Ω , 18pF or less
Instruction Manual.....	B50-2998-00
Replacement Fuse	
2 A	F05-2023-05
1 A	F05-1023-05

OPTIONAL ACCESSORIES

Probe Pouch (MC-78).....	Y87-1600-00
--------------------------	-------------

This soft vinyl pouch attaches to the top side oscilloscope housing and provides storage space for two probes and the operators manual. Install the probe pouch as follow;

1. Unsnap the probe pouch from the retainer plate.
2. Align the retainer plate with 4 holes on the top side of the case, with 4 snaps at the top.
3. Attach the 4 corners of the retainer plate to the oscilloscope case with the 4 nylon rivets supplied.
4. Attach the pouch to the retainer plate using the snap fastener.



A product of
TRIO-KENWOOD CORPORATION
17-5, 2-chome, Shibuya, Shibuya-ku, Tokyo 150, Japan
